



marantz®

Bluetooth CD Receiver
M-CR412

Front panel

Rear panel

Remote control
unit

Index

Owner's Manual



| | |
|--|-----------|
| Accessories | 6 |
| Inserting the batteries | 7 |
| Operating range of the remote control unit | 7 |
| Features | 8 |
| High quality sound | 8 |
| High performance | 9 |
| Part names and functions | 10 |
| Front panel | 10 |
| Rear panel | 13 |
| Remote control unit | 15 |

Connections

| | |
|---|-----------|
| Connecting speakers | 20 |
| Connecting the speaker cables | 20 |
| Connecting the subwoofer | 21 |
| Connecting speaker A (Standard connection) | 21 |
| Connecting speaker B | 22 |
| Connecting the bi-amp | 23 |
| Connecting a digital device | 24 |
| Connecting an analog device | 25 |
| Connecting a USB memory device to the USB port | 26 |
| Connecting a DAB/FM antenna | 27 |
| Connecting the power cord | 28 |



Playback

| | |
|---|-----------|
| Basic operation | 30 |
| Turning the power on | 30 |
| Switching the power to standby | 30 |
| Selecting the input source | 31 |
| Adjusting the volume | 31 |
| Turning off the sound temporarily (Muting) | 31 |
| Playing CDs | 32 |
| Playing CDs | 32 |
| Playing tracks in a specific order (Program playback) | 34 |
| Playing DATA CDs | 35 |
| Playing files | 36 |
| Playing a USB memory device | 38 |
| Playing files stored on USB memory devices | 39 |

| | |
|--|-----------|
| Listening to DAB/FM broadcasts | 41 |
| Listening to DAB/FM broadcasts | 41 |
| Changing the FM reception mode (Tune Mode) | 42 |
| Presetting DAB/FM stations | 42 |
| Automatically presetting FM stations (Auto Preset) | 43 |
| Listening to stations registered in the preset list | 43 |
| Deleting a station from the preset list | 44 |
| Auto scanning DAB broadcast stations | 44 |
| Switching the reception information for the currently tuned in DAB station | 45 |
| RDS search | 45 |
| PTY search | 46 |
| TP search | 47 |
| Radio Text | 47 |
| CT (Clock Time) | 48 |
| Listening to music on a Bluetooth device | 49 |
| Listening to music on a Bluetooth device | 50 |
| Pairing with other Bluetooth devices | 52 |
| Reconnecting to this unit from a Bluetooth device | 52 |



| | |
|--|-----------|
| Playing digital input | 53 |
| Playing analog input | 54 |
| Convenience functions | 55 |
| Adjusting the tone | 56 |
| Switching the display's brightness | 57 |
| Using the sleep timer | 57 |
| Checking the current time | 58 |
| Connecting multi-drive to listen to music in two rooms | 59 |

Settings

| | |
|-----------------------------|-----------|
| Menu map | 61 |
| Menu operation | 64 |
| Audio | 65 |
| H/P Amp Gain | 65 |
| Speaker Config | 65 |
| General | 67 |
| Alarm | 67 |
| Clock | 68 |
| Clock Mode | 69 |
| TV Auto-Play | 69 |
| RC Learning | 70 |
| CD Auto-Play | 70 |
| Illumination | 70 |
| Auto-Standby | 71 |
| Bluetooth | 71 |
| Reset | 71 |
| DAB | 72 |
| Tuning Aid | 72 |
| Station Order | 72 |
| DRC (Dynamic Range Control) | 72 |
| DAB Initialize | 72 |
| DAB Version | 72 |



Tips

| | |
|--|-----------|
| Tips | 74 |
| Troubleshooting | 76 |
| Power does not turn on / Power is turned off | 77 |
| LED is flashing | 77 |
| Operations cannot be performed through the remote control unit | 78 |
| Display on this unit shows nothing | 78 |
| No sound comes out | 79 |
| Sound is interrupted or noise occurs | 80 |
| Desired sound does not come out | 81 |
| USB memory devices cannot be played back | 82 |
| Bluetooth cannot be played back | 83 |
| Cannot playback Discs | 84 |
| Audio from digital devices cannot be played back (Optical) | 85 |
| The input source switches to "Optical In 1" or "Optical In 2" | 85 |

Appendix

| | |
|--|------------|
| Playing back Discs | 86 |
| Files | 86 |
| Playing back a USB memory devices | 88 |
| Playback order of music files | 89 |
| About discs and files | 90 |
| Cautions on using media | 91 |
| Inserting a disc | 91 |
| How to handle media | 92 |
| Cleaning discs | 92 |
| DIGITAL IN | 93 |
| Playing back a Bluetooth device | 93 |
| Last function memory | 93 |
| Explanation of terms | 94 |
| Trademark information | 97 |
| Specifications | 98 |
| Index | 103 |







Thank you for purchasing this Marantz product.

To ensure proper operation, please read this owner's manual carefully before using the product.

After reading this manual, be sure to keep it for future reference.

Accessories

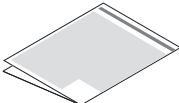
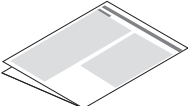
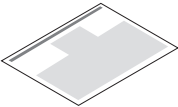
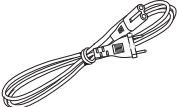
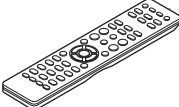
Check that the following parts are supplied with the product.

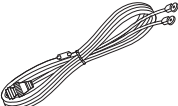
| | | | |
|---|--|--|--|
|  Quick Start Guide |  Safety Instructions |  Cautions on Using Batteries |  Notes on radio |
|  Location of Caution Labels |  Power cord |  Remote control unit (RC015CR) |  R03/AAA batteries |
|  DAB/FM indoor antenna | | | |



Inserting the batteries

- 1 Remove the rear lid in the direction of the arrow and remove it.



- 2 Insert two batteries correctly into the battery compartment as indicated.

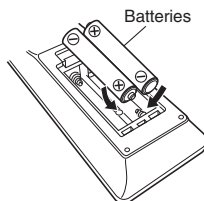

- 3 Put the rear cover back on.

NOTE

- To prevent damage or leakage of battery fluid:
 - Do not use a new battery together with an old one.
 - Do not use two different types of batteries.
- Remove the batteries from the remote control unit if it will not be in use for long periods.
- If the battery fluid should leak, carefully wipe the fluid off the inside of the battery compartment and insert new batteries.

Operating range of the remote control unit

Point the remote control unit at the remote sensor when operating it.

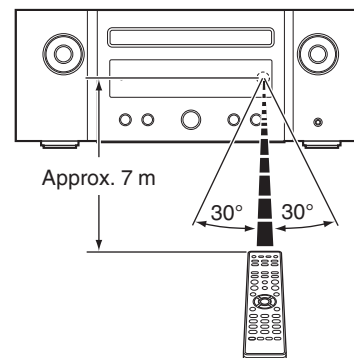

Features

High quality sound

- **Equipped with a digital amplifier with high audio quality and high output**

This unit has a 50 W+50 W (6 Ω /ohms) high-output class D amplifier. Full digital processing is used to perform all processes in the digital domain during playback of digital sources, eliminating external noise. Pattern minimizing is also used to achieve high-quality playback.

- **Adoption of a bi-amp system that realizes high quality audio**

The low and high range speaker units of bi-amp compatible speakers are each driven by independent amps to eliminate interference and realize audio playback that is more faithful to the source.

- **Bluetooth OFF mode for highest sound performance**

The Bluetooth OFF mode is used to turn off the Bluetooth function, as this function is a source of noise that affects sound quality. Suppressing this noise enables high sound performance playback.



High performance

- **Equipped with optical digital audio input, enabling connection with digital devices such as TVs**

Connect this unit to digital devices such as TVs using the optical digital cable to enjoy audio from the TV and a variety of content in high audio quality. This unit also has an automatic playback function. When a device connected to this unit by digital connection is turned on, this unit automatically turns on and plays audio from the device.

- **Can be operated with the remote control of your TV**

By learning the infrared signal of the remote control of your TV, you can operate this unit with the remote control of the TV. (👉 p. 70)

- **Wireless connection with Bluetooth devices can be carried out easily**

You can enjoy music simply by connecting wirelessly with your smartphone, tablet, PC, etc.

- **Supported with “Multi-Drive Connection” for simultaneous or switchable sound in 2 sets of speakers**

- **Supports MP3 and WMA file CD playback**

MP3 and WMA files that have been recorded onto CD-R or CD-RW discs can be played back on this CD player.

- **Plays USB memory devices (MP3/WMA/AAC/WAV/FLAC/Apple Lossless/AIFF/DSD).**

You can play back audio files stored on a USB memory device by connecting the USB memory device to the USB port.

- **Headphone Amplifier Gain selector function**

This unit has a gain control function with three levels that can be switched according to the characteristics of the connected headphones.

- **Equipped with auto standby mode function that reduces power consumption**



Part names and functions

Front panel

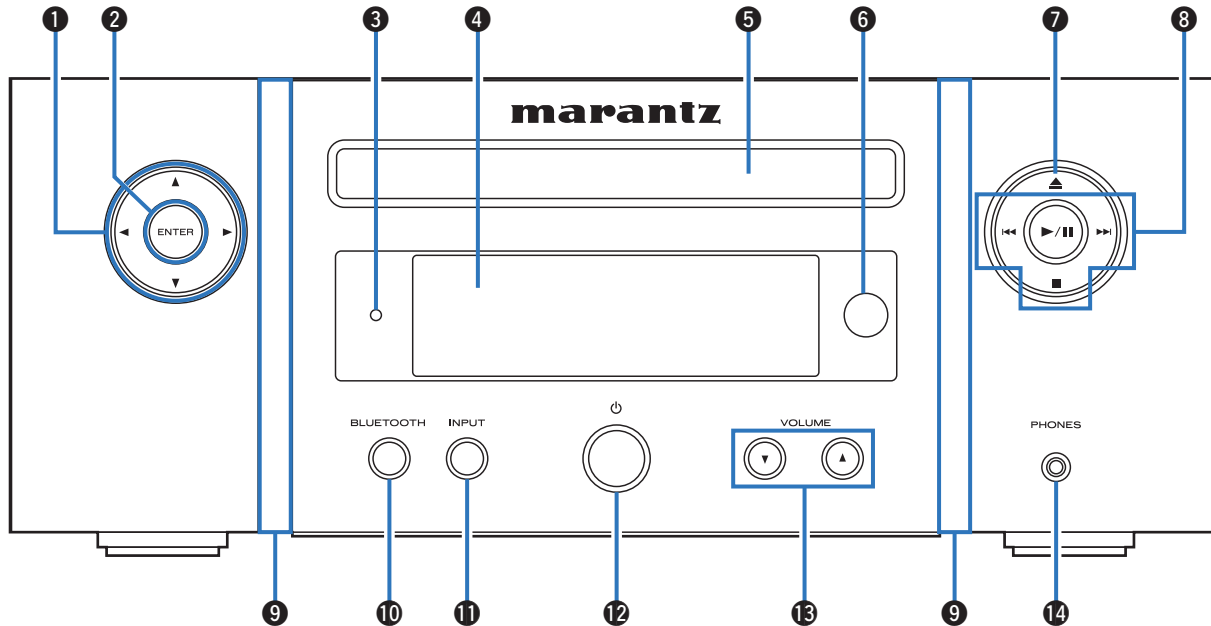

For details, see the next page.



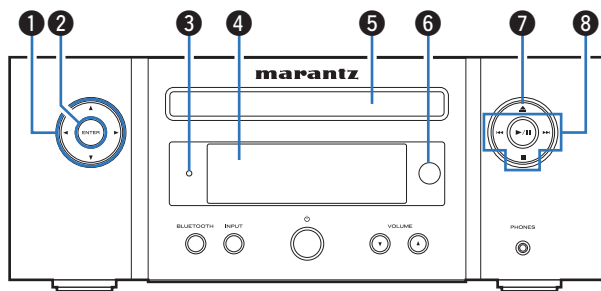

1 Cursor buttons (Δ▽◀▶)

These select items.

2 ENTER button

This determines the selection.

3 Standby indicator

Lights as follows according to unit status:

- Not lit:
 - When powered on
 - During normal standby ("TV Auto-Play"-Off" (👉 p. 69))
- Green: When display brightness is off (👉 p. 57)
- Orange: During alarm standby (👉 p. 67)
- Red:
 - During normal standby ("TV Auto-Play"-Optical In 1/Optical In 2" (👉 p. 69))
 - When Bluetooth is on standby (👉 p. 71)

4 Display

This displays various pieces of information.

5 Disc tray

Used to insert a disc. (👉 p. 91)

6 Remote control sensor

This receives signals from the remote control unit. (👉 p. 7)

7 Disc tray open/close button (▲)

Opens and closes the disc tray. (👉 p. 32)

8 System buttons

These perform playback related operations.



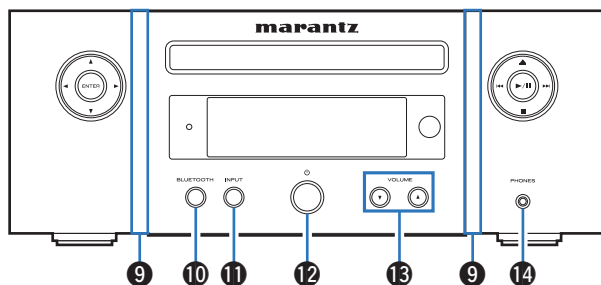

9 Front panel illumination

Lights when power is turned on. Illumination output can be set on/off using "Illumination" in the settings menu. (☞ p. 70)

10 BLUETOOTH button

This switches the input to Bluetooth. This is also pressed during the pairing operation. (☞ p. 49)

11 INPUT button

This selects the input source. (☞ p. 31)

12 Power operation button (⏻)

This turns the power on/off (standby). (☞ p. 30)

13 Volume up/down buttons (VOLUME ▲▼)

Adjusts the volume. (☞ p. 31)

14 Headphones jack (PHONES)

Used to connect headphones.

When the headphones are plugged into this jack, audio will no longer be output from the connected speakers.

NOTE

- To prevent hearing loss, do not raise the volume level excessively when using headphones.



Rear panel

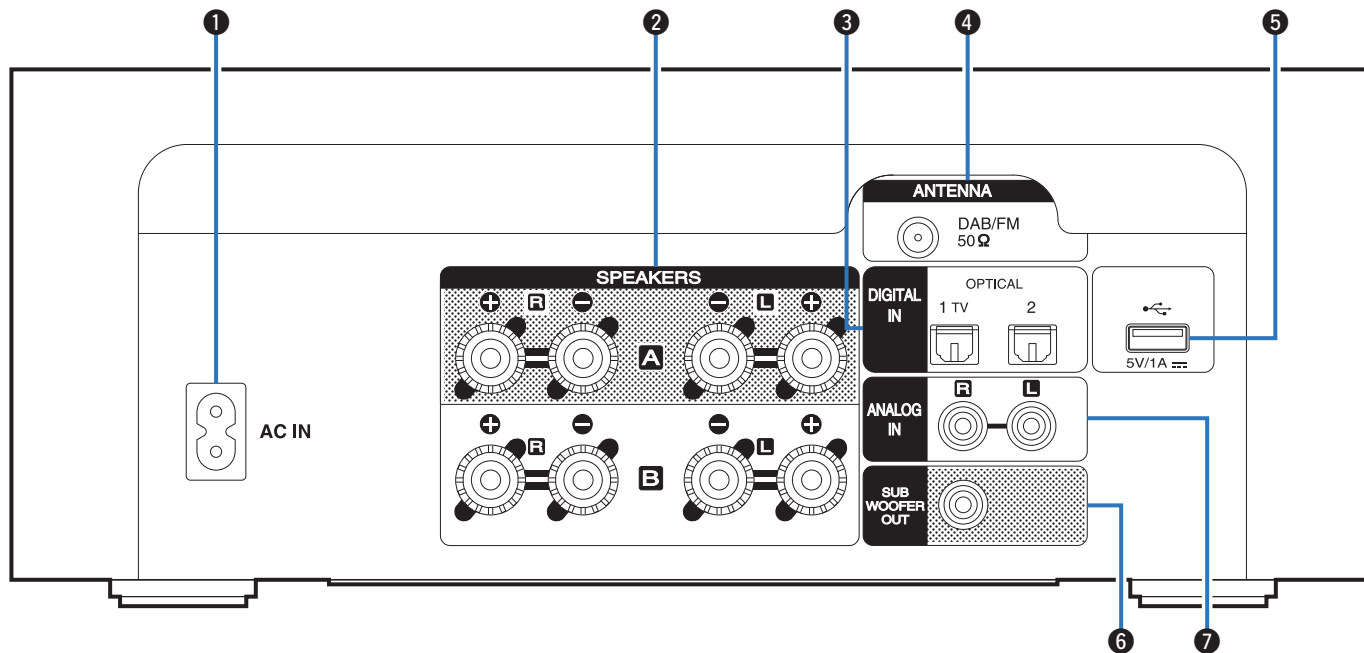

For details, see the next page.



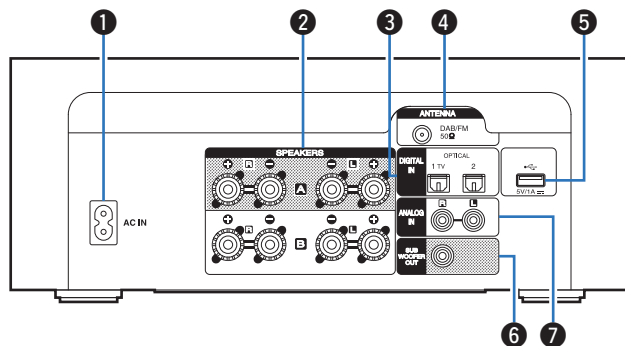

1 AC inlet (AC IN)

Used to connect the power cord. (☞ p. 28)

2 Speaker terminals (SPEAKERS)

Used to connect speakers. (☞ p. 20)

3 DIGITAL IN connectors

Connecting to a device with digital audio output connectors.
(☞ p. 24)

4 DAB/FM antenna terminal (ANTENNA)

Used to connect a DAB/FM antenna. (☞ p. 27)

5 USB port (☞)

This is used to connect USB storages (such as USB memory devices).
(☞ p. 26)

6 SUBWOOFER OUT connector

Used to connect a subwoofer with a built-in amplifier. (☞ p. 21)

7 ANALOG IN connectors

Connecting to a device with analog audio output connectors.
(☞ p. 25)



Remote control unit

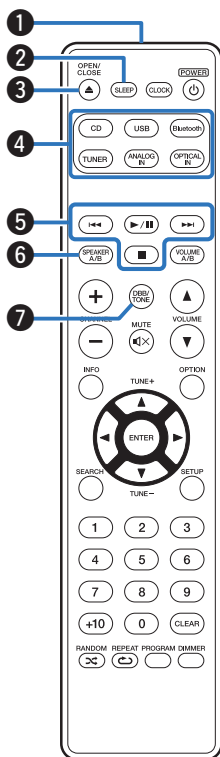

1 Remote control signal transmitter

This transmits signals from the remote control unit. (☞ p. 7)

2 SLEEP button

This sets the sleep timer. (☞ p. 57)

3 OPEN/CLOSE button (▲)

Opens and closes the disc tray. (☞ p. 32)

4 Input source select buttons

These select the input source. (☞ p. 31)

5 System buttons

These perform playback related operations.

6 SPEAKER A/B button

Used to switch the speaker for audio output. (☞ p. 60)

7 DBB/TONE button

Adjusting the tone. (☞ p. 56)



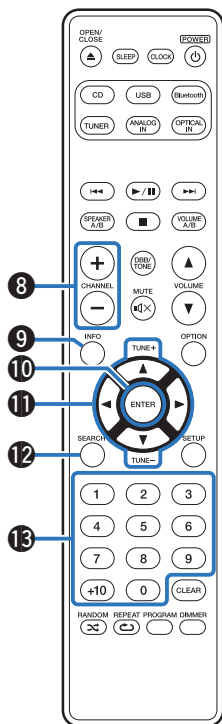

8 CHANNEL buttons (+, -)

These select preset broadcast stations. (☞ p. 41)

9 Information button (INFO)

This switches the track information shown in the display during playback.

10 ENTER button

This determines the selection.

11 Cursor buttons (Δ▽◀▶)

These select items.

Tuning buttons (TUNE +, -)

These operate the tuner. (☞ p. 41)

12 SEARCH button

This displays the search menu.

13 Number buttons (0 - 9, +10)

These enter numbers.



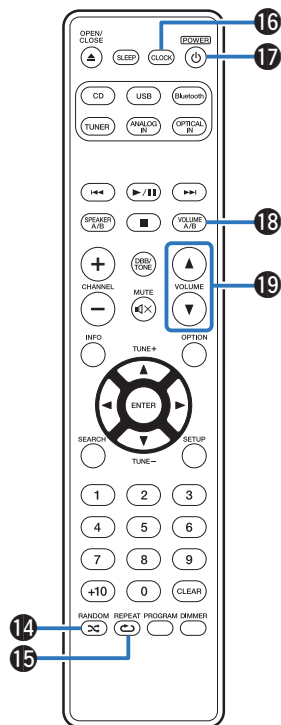

14 **RANDOM** button (∞)

Switches the random playback.

15 **REPEAT** button (↺)

Switches the repeat playback.

16 **CLOCK** button

The current time appear on the unit. (☞ p. 58)

17 **Power operation button (POWER ⏻)**

This turns the power on/off (standby). (☞ p. 30)

18 **VOLUME A/B** button

Used to select the speaker for volume adjustment when 2 sets of speakers (Speaker A/Speaker B) are connected. (☞ p. 60)



- This is only enabled when “Speakers A+B” is set for the audio output speakers. (☞ p. 60)

19 **VOLUME** buttons (▲▼)

Adjusts the volume. (☞ p. 31)



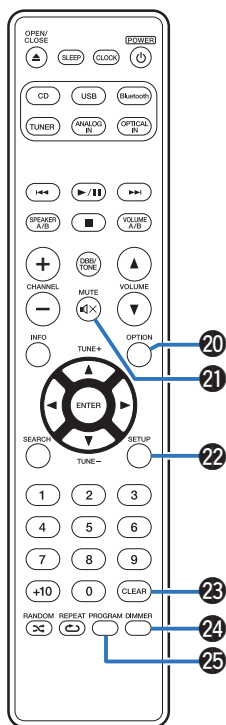

20 OPTION button

- This displays the option menu on the display.



- An option menu is not displayed for some input sources.

- This switches the playback range on a data CD. (☞ p. 37)

21 MUTE button (M)

This mutes the output audio. (☞ p. 31)

22 SETUP button

The setting menu is displayed on the display. (☞ p. 64)

23 CLEAR button

This cancels the settings.

24 DIMMER button

Adjust the display brightness of this unit. (☞ p. 57)

25 PROGRAM button

This sets program playback. (☞ p. 34)



■ Contents

| | |
|--|----|
| Connecting speakers | 20 |
| Connecting a digital device | 24 |
| Connecting an analog device | 25 |
| Connecting a USB memory device to the USB port | 26 |
| Connecting a DAB/FM antenna | 27 |
| Connecting the power cord | 28 |

NOTE

- Do not plug in the power cord until all connections have been completed.
- Do not bundle power cords with connection cables. Doing so can result in humming or noise.

■ Cables used for connections

Provide necessary cables according to the devices you want to connect.

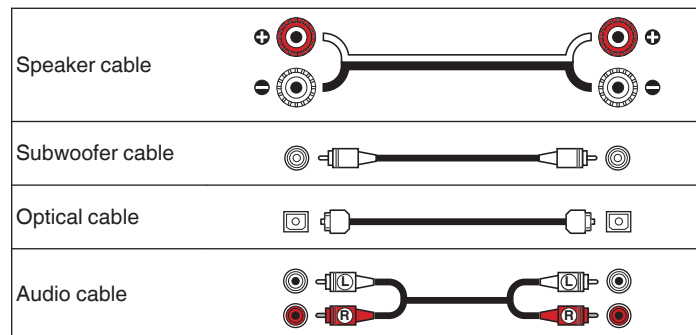

Connecting speakers

Here we connect the speakers in the room to this unit.

This section explains how to connect them using typical examples.

NOTE

- Disconnect this unit's power plug from the power outlet before connecting the speakers. Also, turn off the subwoofer.
- Connect so that the speaker cable core wires do not protrude from the speaker terminal. The protection circuit may be activated if the core wires touch the rear panel or if the + and - sides touch each other. "Protection circuit" (☞ p. 96)
- Never touch the speaker terminals while the power cord is connected. Doing so could result in electric shock.
- Use speakers with an impedance of 4 – 16 Ω/ohms.

Connecting the speaker cables

Connect the speaker cable to the + speaker terminal (red) and the - speaker terminal (black).

- 1 Peel off about 10 mm of sheathing from the tip of the speaker cable, then twist the core wire tightly.**



- 2 Turn the speaker terminal counterclockwise to loosen it.**



- 3 Insert the speaker cable's core wire to the hilt into the speaker terminal.**

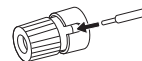

- 4 Turn the speaker terminal clockwise to tighten it.**

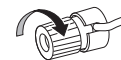

Connecting the subwoofer

Use a subwoofer cable to connect the subwoofer.

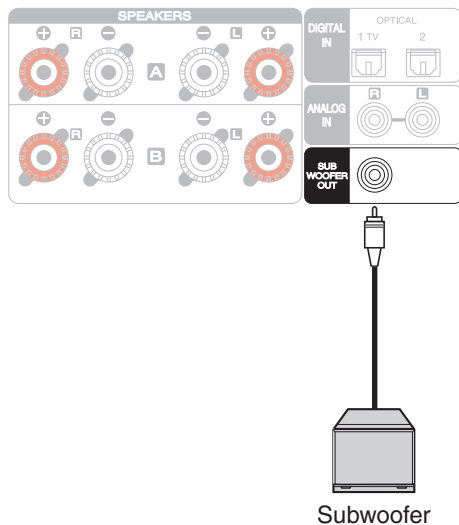

Connecting speaker A (Standard connection)

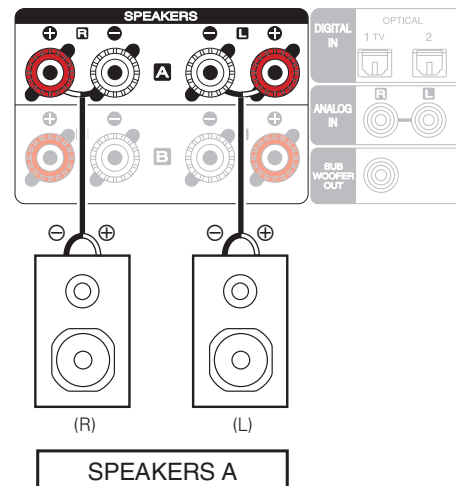

- The subwoofer volume is linked to the Speaker A volume.
- When the speaker for audio output is set to "Speakers B", this unit does not output to the subwoofer. (🔗 p. 60)



Connecting speaker B

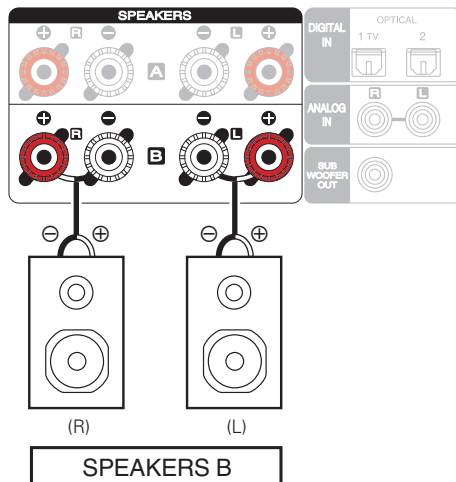

- When using this connection, set "Speaker Config"-"Amplifier Mode" in the settings menu to "Standard". (🔗 p. 65)
- By connecting speaker B in addition to speaker A, multi-drive connection can be performed to enjoy audio output separately or from both speakers. (🔗 p. 59)



Connecting the bi-amp

Bi-amp connection is a method to connect separate amplifiers to the tweeter terminal and woofer terminal of a speaker that supports bi-amplification. This connection enables back EMF (power returned without being output) from the woofer to flow into the tweeter without affecting the sound quality, producing a higher sound quality.

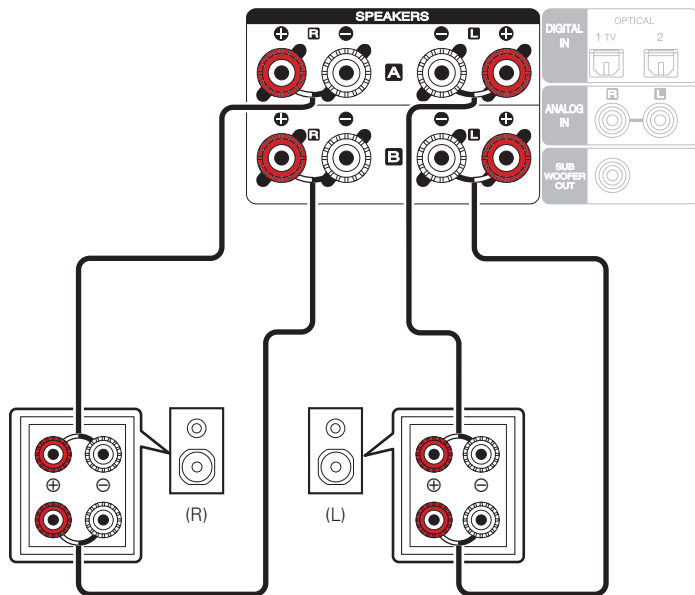

- When using this connection, set “Speaker Config”–“Amplifier Mode” in the settings menu to “Bi-Amp”. (🔍 p. 65)

NOTE

- When making bi-amp connections, be sure to remove the short-circuiting plate or wire between the speaker’s woofer and tweeter terminals.



Connecting a digital device

Connect this unit to a device with digital output connectors, such as a TV.

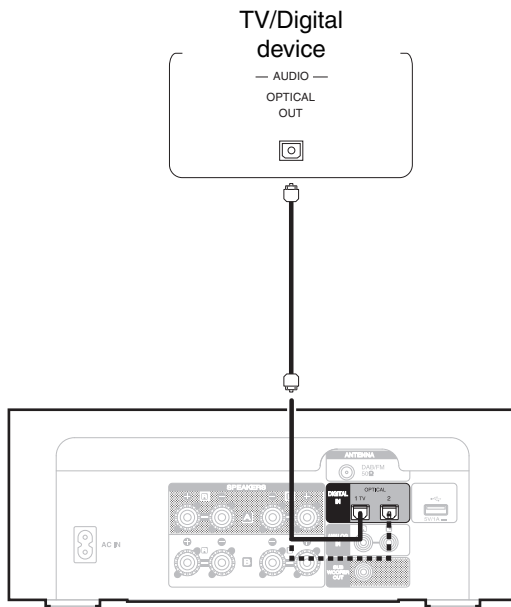

- When connecting a TV to this unit, turn off the audio output of the TV's internal speakers. See the owner's manual of your TV for details.

■ Specifications of supported audio formats

See "DIGITAL IN" (👉 p. 93).



Connecting an analog device

You can connect this unit to various devices with analog audio output.

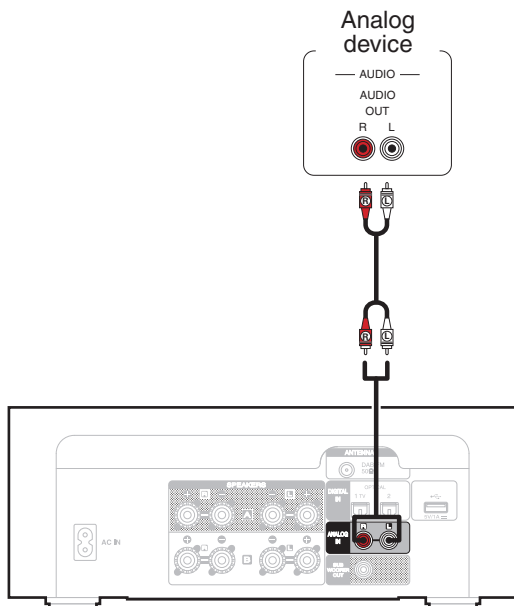

Connecting a USB memory device to the USB port

For operating instructions see “Playing a USB memory device”. (🔗 p. 38)

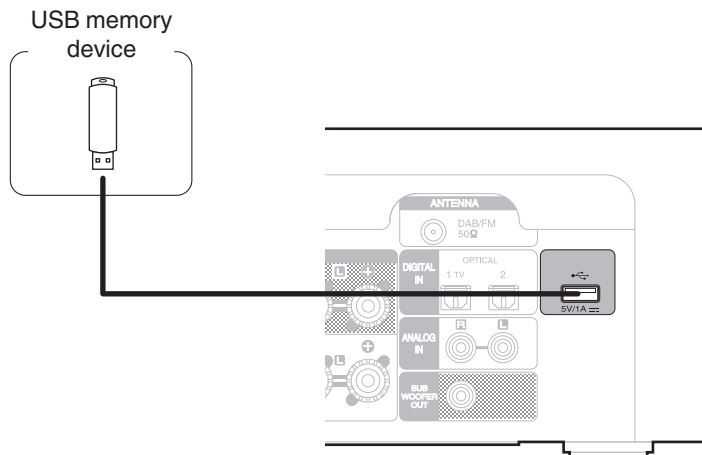

- Marantz does not guarantee that all USB memory devices will operate or receive power. When using a portable USB hard disk drive (HDD) which came with an AC adapter, use that device's supplied AC adapter.

NOTE

- USB memory devices will not work via a USB hub.
- It is not possible to use this unit by connecting the unit's USB port to a PC via a USB cable.
- Do not use an extension cable when connecting a USB memory device. This may cause radio interference with other devices.



Connecting a DAB/FM antenna

After connecting the antenna and receiving a broadcast signal, fix the antenna with tape in a position where the noise level becomes minimal. “Listening to DAB/FM broadcasts” (👉 p. 41)

DAB/FM indoor antenna (supplied)

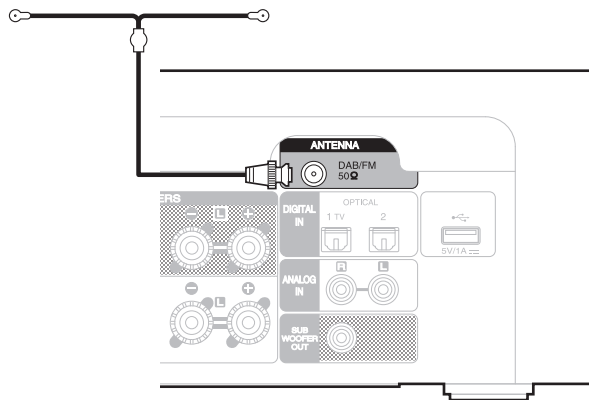

- For best results with the supplied indoor antenna, orient the antenna along a wall such that it is stretched out horizontally and parallel to the floor (but above the floor), and then fasten the two end tabs to the wall. This type of antenna is directional and best results will be obtained when it is correctly oriented toward the transmitting location.
- For example, if the transmission tower is to the north, then the two ends of the antenna (with the tabs) should be stretched toward west and east.
- If you are unable to receive a good broadcast signal, we recommend installing an outdoor antenna. For details, inquire at the retail store where you purchased the unit.



Connecting the power cord

After completing all the connections, insert the power plug into the power outlet.

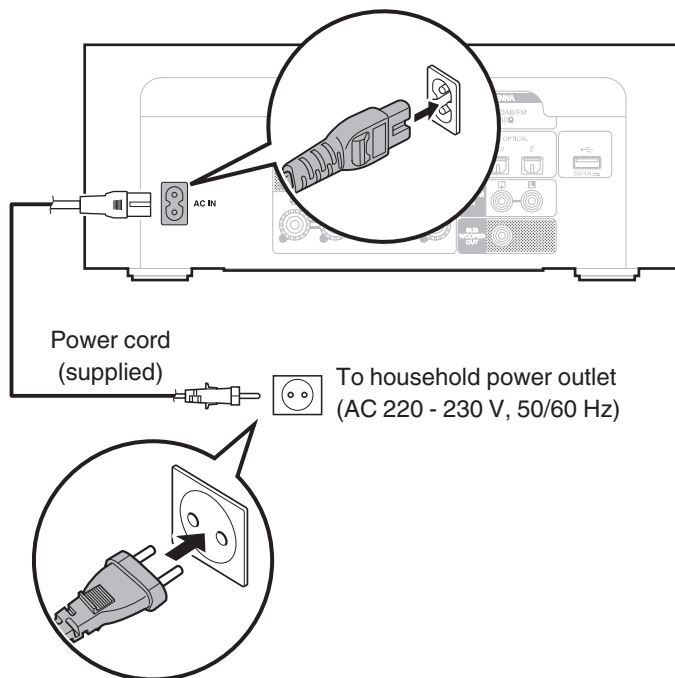

■ Contents

Basic operation

| | |
|--|----|
| Turning the power on | 30 |
| Switching the power to standby | 30 |
| Selecting the input source | 31 |
| Adjusting the volume | 31 |
| Turning off the sound temporarily (Muting) | 31 |

Playback a device

| | |
|--|----|
| Playing CDs | 32 |
| Playing DATA CDs | 35 |
| Playing a USB memory device | 38 |
| Listening to DAB/FM broadcasts | 41 |
| Listening to music on a Bluetooth device | 49 |
| Playing digital input | 53 |
| Playing analog input | 54 |

Convenience functions

| | |
|--|----|
| Adjusting the tone | 56 |
| Switching the display's brightness | 57 |
| Using the sleep timer | 57 |
| Checking the current time | 58 |
| Connecting multi-drive to listen to music in two rooms | 59 |



Basic operation

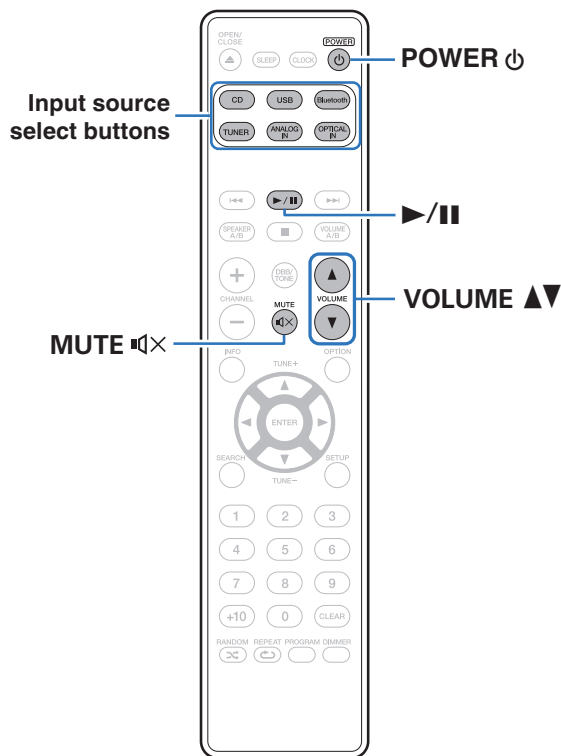

Turning the power on

1 Press **POWER** ⏻ to turn on power to the unit.



- You can also press ⏻ on the main unit to turn on power from standby mode.
- You can also press ▶/|| to turn on power from standby mode.

Switching the power to standby

1 Press **POWER** ⏻.

The unit switches to standby mode.



- You can also switch the power to standby by pressing ⏻ on the main unit.

NOTE

- Power continues to be supplied to some of the circuitry even when the power is in the standby mode. When leaving home for long periods of time or when going on vacation, unplug the power cord from the power outlet.



Selecting the input source

1 Press the input source select button to be played back.

The selected input source appears on the display.



- This unit switches between DAB and FM each time TUNER is pressed.
- This unit switches Optical In 1/2 each time OPTICAL IN is pressed.
- You can also select the input source by pressing INPUT on the main unit. However, to select Bluetooth, press BLUETOOTH on the main unit.

Adjusting the volume

1 Use VOLUME ▲▼ to adjust the volume.

The volume level appears on the display.



- You can also adjust the volume by pressing VOLUME ▲▼ on the main unit.

Turning off the sound temporarily (Muting)

1 Press MUTE .

"Mute" is displayed on the display.



- To cancel mute, either adjust the volume or press MUTE  again.



Playing CDs

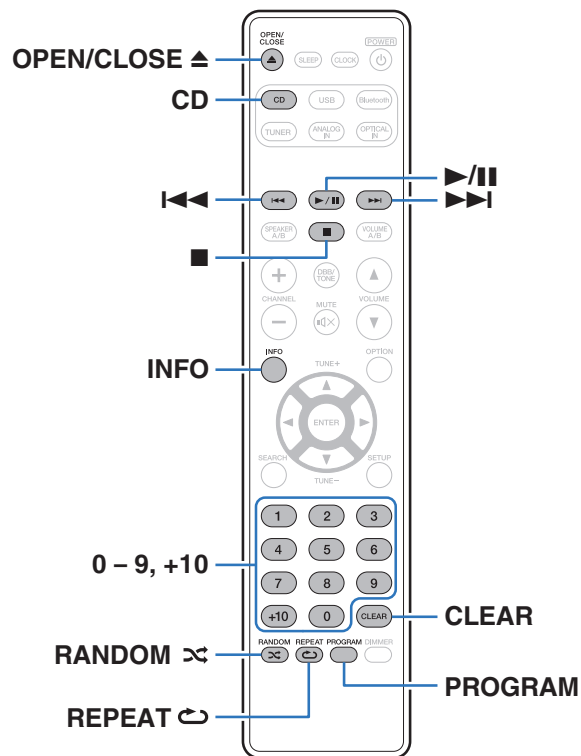

Playing CDs

1 Press CD to switch the input source to “CD”.

2 Insert a disc. (🔗 p. 91)

Playback starts.

- Press OPEN/CLOSE ▲ to open/close the disc tray.







- You can also open/close the disc tray by pressing ▲ on the main unit.
- You can set whether to automatically play CDs. (🔗 p. 70)

NOTE

- Do not place any foreign objects in the disc tray. Doing so could damage the set.
- Do not push the disc tray in by hand when the power is turned off. Doing so could damage the set.



| Operation buttons | Function |
|---|---|
|  | Playback / Pause |
|  | Stop |
|  | Skip to previous track / Skip to next track |
| | (Press and hold) Fast-reverse / Fast-forward |
| 0 - 9, +10 | Select the track |
| RANDOM  | Random playback |
| REPEAT  | Repeat playback <ul style="list-style-type: none"> Switching between All-track repeat and Single-track repeat. |
| INFO | Time display switching <ul style="list-style-type: none"> Switching between elapsed time of the current track, remaining time of the current track and remaining time of all tracks. |

■ Playing a specific track (Direct searching)

1 Use 0 - 9, +10 to select the tracks.

[Example]

Track 4 : Press number 4 to select track 4.

Track 12 : Press numbers +10 and 2 consecutively to select track 12.



Playing tracks in a specific order (Program playback)

Up to 25 tracks can be programmed.

1 In the stop mode, press PROGRAM.

“Program” is displayed on the display.

2 Use 0 – 9, +10 to select the tracks.

[Example]



Track 4 : Press number 4 to select track 4.

Track 12 : Press numbers +10 and 2 consecutively to select track 12.

3 Press ►/II.

Playback starts in the programmed order.



- The program is cleared when the disc tray is opened or the power is turned off.
- When RANDOM  is pressed during program playback, the programmed tracks are played in random order.
- When REPEAT  is pressed during program playback, the tracks are played repeatedly in the programmed order.

■ Checking the order of the programmed tracks

In the stop mode, press ►►I.

The tracks are shown in the programmed order in the display each time ►►I is pressed.

■ Clears the programmed tracks

In the stop mode, press CLEAR.

The last track programmed is cleared each time the button is pressed.



- You can also select a track to be cleared by pressing ►►I.

■ Clearing the all programmed track

In the stop mode, press PROGRAM.



Playing DATA CDs

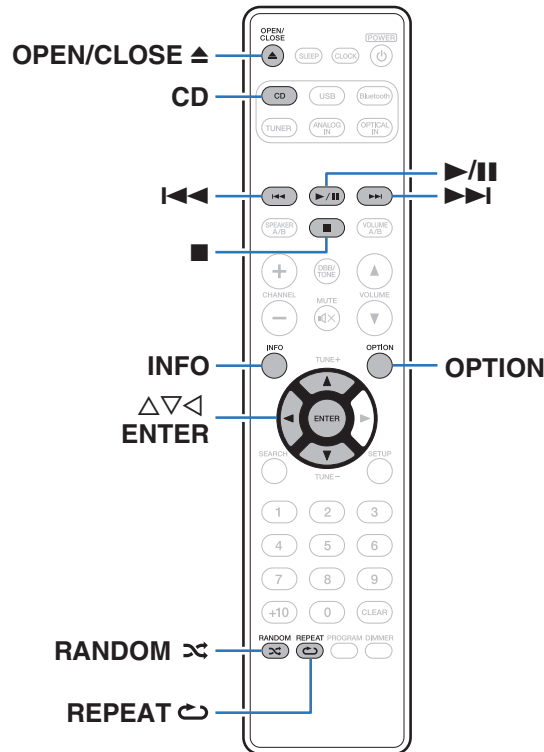

- This section explains how to playback music files that are recorded onto a CD-R or CD-RW.
- There are many music distribution sites on the Internet allowing you to download music files in MP3 or WMA (Windows Media® Audio) format. The music (files) downloaded from such sites can be stored on CD-R or CD-RW discs and played on this unit.
- The audio format types and specifications supported by this unit for playback are as follows.
See “Specifications of supported files” (p. 87) for details.
 - **MP3**
 - **WMA**

NOTE

- Copyright-protected files cannot be played.
- Note that depending on the software used for burning and other conditions, some files may not play or display correctly.

“Windows Media” and “Windows” are the trademarks or registered trademarks of Microsoft Corporation in the United States and other countries.



Playing files









- 1 Press **CD** to switch the input source to “CD”.
- 2 Load a CD-R or CD-RW containing music files into the disc tray. (🔧 p. 91)

Playback starts.



- Press **OPEN/CLOSE**  to open/close the disc tray.



- You can also open/close the disc tray by pressing  on the main unit.
- You can set whether to automatically play CDs. (🔧 p. 70)

| Operation buttons | Function |
|---|---|
|  | Playback / Pause |
|  | Stop |
|  | Skip to previous track / Skip to next track |
|  | (Press and hold) Fast-reverse / Fast-forward |
|  | Moving up a level in the hierarchy |
|  | Select the item |
| ENTER | Enter the selected item / Playback |
| OPTION | Select the playback range |
| RANDOM  | Random playback |
| REPEAT  | Repeat playback <ul style="list-style-type: none"> • Switching between All-track repeat and Single-track repeat. |
| INFO | Switches the display between Title name / Artist name, Title name / Album name and File name. |



- To start playing another file during playback of a CD-R/CD-RW, first press  to display the file tree. Next, use  to select the file to be played and press **ENTER**.



■ Switching the display

During playback, press INFO.

- Switches the display between Title name / Artist name, Title name / Album name and File name.
- If a file does not support text information or no track information is recorded, the file name is displayed.
- The player can display the following characters:

ABCDEFGHIJKLMNOPQRSTUVWXYZ

abcdefghijklmnopqrstuvwxyz

0123456789

!"#\$%&:;<>?@\[_`!{|}~^'()*+,-./= space

- Any characters that cannot be displayed are replaced with "." (period).
- The folder and file numbers are set automatically when the disc is loaded.

■ Switching the playback range

Press OPTION.

- The playback range of a track can be set.

Folder mode:

All the files in the selected folder are played. The "FLD" indicator on the display lights at this time.

All mode:

All the files in the disc are played.



Playing a USB memory device

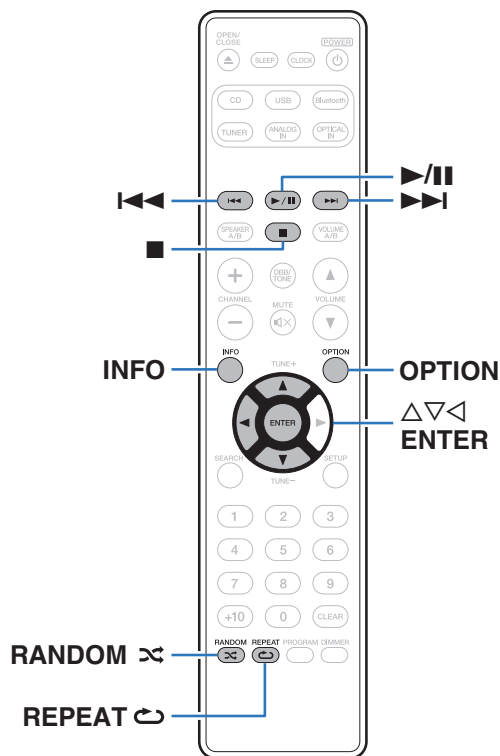

- Playing back music files stored on a USB memory device.
- Only USB memory devices conforming to mass storage class standards can be played on this unit.
- The audio format types and specifications supported by this unit for playback are as follows.
See “Playing back a USB memory devices” (👉 p. 88) for details.

- WMA
- MP3
- WAV
- MPEG-4 AAC
- FLAC
- Apple Lossless
- AIFF
- DSD



Playing files stored on USB memory devices







1 Insert a USB memory device into the rear panel's USB port.

When you insert a USB memory device in the USB port, the input source automatically switches to "USB Music".

2 Use $\Delta \nabla$ to select the folder to be played, then press ENTER.

3 Use $\Delta \nabla$ to select the file to be played, then press ENTER.

Playback starts.

| Operation buttons | Function |
|--|---|
|  | Playback / Pause |
|  | Stop |
|  | Skip to previous track / Skip to next track (Press and hold) Fast-reverse / Fast-forward |
|  | Moving up a level in the folder tree |
| $\Delta \nabla$ | Select the item |
| ENTER | Enter the selected item / Playback |
| OPTION | Select the playback range |
| RANDOM  | Random playback |
| REPEAT  | Repeat playback <ul style="list-style-type: none"> Switching between All-track repeat and Single-track repeat. |
| INFO | Switches the display between Title name / Artist name, Title name / Album name and File name. |



- To start playing another file during playback of a USB memory device, first press \triangleleft to display the file tree. Next, use $\Delta \nabla$ to select the file to be played and press ENTER.



NOTE

- Note that Marantz will accept no responsibility whatsoever for any problems arising with the data on a USB memory device when using this unit in conjunction with the USB memory device.
- When a USB memory device is connected to this unit, the unit loads all of the files on the USB memory device. Loading may take a while if the USB memory device contains a large number of folders and/or files.

■ Switching the playback range

Press OPTION.

- The playback range of a track can be set.

| | |
|---------------------|--|
| Folder mode: | All the files in the selected folder are played. The “FLD” indicator on the display lights at this time. |
| All mode: | All the files in the USB memory are played. |



Listening to DAB/FM broadcasts

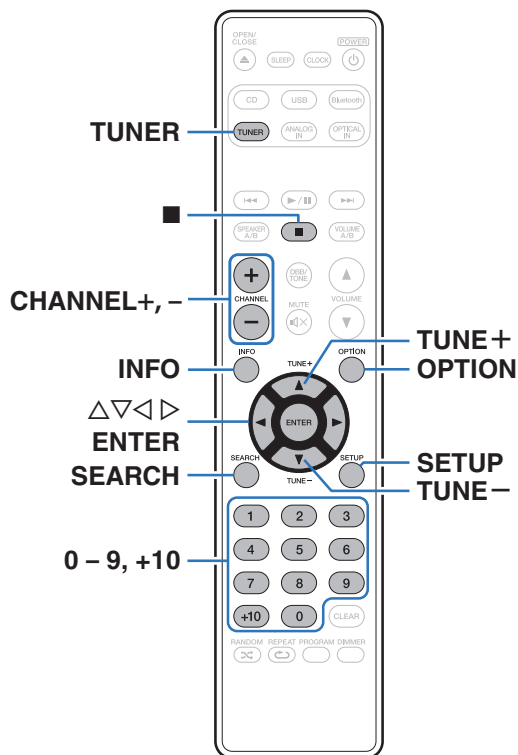

For details about how to connect the antenna, see “Connecting a DAB/FM antenna” (🔧 p. 27).

📄 About DAB+

- The main difference between DAB and DAB+ is the type of audio codec used.
DAB: MPEG2
DAB+: MPEG4 (AAC)
- This unit can receive both DAB and DAB+ broadcasts.

Listening to DAB/FM broadcasts

1 Press TUNER to select the reception band.

DAB: When listening to a DAB broadcast.

FM: When listening to an FM broadcast.

- Automatically scans for DAB stations when DAB is selected for the first time after purchase.

2 Press TUNE + or TUNE - to select the station you want listen to.

When a station is received, the “TUNED” indicator lights.



- You can also select the station by pressing $\Delta \nabla$ on the main unit.



Changing the FM reception mode (Tune Mode)

Change the reception mode to FM. If you cannot tune in automatically with “Auto” mode, change the mode to “Manual” mode and tune in manually.

- 1 Press OPTION during FM reception.**
An option menu is displayed.
- 2 Use $\Delta\nabla$ to select “Tune Mode” then press ENTER.**
- 3 Use $\Delta\nabla$ to change to desired setting, then press ENTER to enter the setting.**

Auto: Automatically search for and tune to a receivable radio station.

Manual: Manually change the frequency one step at a time each time the button is pressed.

- When “Tune Mode” is set to “Auto”, the “AUTO” indicator lights.
- When “Tune Mode” is set to “Auto” and a stereo broadcast is received, the “ST” indicator lights.

Presetting DAB/FM stations

Up to 40 stations can be registered in the preset list.

- 1 Press OPTION during reception of the station to be registered.**
An option menu is displayed.
- 2 Use $\Delta\nabla$ to select “Preset Memory”, then press ENTER.**
- 3 Use 0 – 9, +10 or CHANNEL + and – to select the number to be preset, then press ENTER.**



- When a registered preset number is selected, “*” is displayed. To overwrite the preset details for this preset number, press ENTER.
- A maximum of 30 DAB broadcast stations can be preset.



Automatically presetting FM stations (Auto Preset)

You can automatically register all FM stations that can be received to the preset list. Up to 40 stations can be registered.

1 Press SEARCH during FM reception.

This displays the search menu.

2 Use $\Delta\nabla$ to select “Auto Preset”, then press ENTER.

3 Press ENTER while “Press Enter” is flashing.

The unit starts to tune in to radio stations automatically and preset them.

- When presetting is completed, “Auto Preset Complete” is displayed.



- To stop auto tuning, press ■.
- Broadcast stations whose antenna signals are weak cannot be preset automatically. If you wish to preset such stations, tune them in manually.
- Additional stations cannot be registered to the preset list after 40 stations are registered.
- DAB stations cannot be automatically preset.
- When auto preset is used, the previous FM preset information is erased and the new FM station is registered.

Listening to stations registered in the preset list

1 Use 0 – 9, +10 or CHANNEL + and – to select the preset number.



- You can also select the preset number by pressing \triangleleft \triangleright on the main unit.



Deleting a station from the preset list

- 1 Press OPTION while receiving the station for the preset number you want to erase.**
An option menu is displayed.
- 2 Use $\Delta\nabla$ to select “Remove Preset”, then press ENTER.**
- 3 Press ENTER while “Delete OK?” is flashing.**

Auto scanning DAB broadcast stations

- 1 Press SEARCH during DAB reception.**
“DAB Auto Scan” is displayed on the display.
- 2 Press ENTER.**
Begins scanning for DAB stations.



Switching the reception information for the currently tuned in DAB station

1 Press INFO during DAB reception.

| | |
|-------------------------------|--|
| Dynamic Label Segment: | Text data included in the broadcast is scrolled. |
| Station Name: | The service station name is displayed. |
| Program Type: | The category of the tuned in station is displayed. |
| Ensemble Name: | The ensemble name is displayed. |
| Frequency: | The frequency is displayed. |
| Signal Quality: | <p>The reception signal intensity is displayed (0 to 8).</p> <ul style="list-style-type: none"> If the reception signal intensity is 5 or greater, the program can be received without noise. |
| Audio Information: | The mode of the currently tuned in station and its bit rate are displayed. |

RDS search

RDS is a broadcasting service which allows a station to send additional information along with the regular radio program signal.

Use this function to automatically tune to FM stations that provide the RDS service.

Note that the RDS function only works when receiving RDS compatible stations.

1 Press SEARCH during FM reception.

This displays the search menu.

2 Use $\Delta\nabla$ to select "RDS Search", then press ENTER.

3 Press $\triangleleft\rangle$.

The search for RDS stations begins automatically.

- If an RDS broadcast station cannot be found, "No Station" appears in the display.



- The display switches between Frequency, Program Type, Clock time and Radio Text each time the INFO is pressed.
- The operations described below selecting "RDS Search" will not function in areas in which there are no RDS broadcasts.



PTY search

Use this function to find RDS stations broadcasting your desired program type (PTY).

PTY identifies the type of RDS program.

The program types and their displays are as follows:

| | | | |
|-----------------|----------------------|-----------------|--------------------|
| NEWS | News | WEATHER | Weather |
| AFFAIRS | Current Affairs | FINANCE | Finance |
| INFO | Information | CHILDREN | Children's program |
| SPORT | Sports | SOCIAL | Social Affairs |
| EDUCATE | Education | RELIGION | Religion |
| DRAMA | Drama | PHONE IN | Phone In |
| CULTURE | Culture | TRAVEL | Travel |
| SCIENCE | Science | LEISURE | Leisure |
| VARIED | Varied | JAZZ | Jazz Music |
| POP M | Pop Music | COUNTRY | Country Music |
| ROCK M | Rock Music | NATION M | National Music |
| EASY M | Easy Listening Music | OLDIES | Oldies Music |
| LIGHT M | Light Classical | FOLK M | Folk Music |
| CLASSICS | Serious Classical | DOCUMENT | Documentary |
| OTHER M | Other Music | | |

1 Press **SEARCH** during FM reception.

This displays the search menu.

2 Use $\Delta\nabla$ to select "PTY Search", then press **ENTER**.

3 Use $\Delta\nabla$ to select the desired program type.

4 Press $\triangleleft\triangleright$.

Automatically begin the PTY search operation.

- If the RDS broadcast station corresponding to the selected program cannot be found, "No Station" appears in the display.



TP search

TP identifies programs that carry traffic announcements.

This allows you to easily find out the latest traffic conditions in your area before leaving home.

Use this function to find RDS stations broadcasting traffic programs (TP stations).

1 Press SEARCH during FM reception.

This displays the search menu.

2 Use $\Delta\nabla$ to select “TP Search”, then press ENTER.

3 Press $\triangleleft\triangleright$.

Automatically begin the TP search operation.

- If the RDS broadcast station set for the traffic program (TP) cannot be found, “No Station” appears in the display.

Radio Text

RT allows RDS stations to send text messages that appear on the display.



- If an RDS broadcast station is not offering an RT service, “No RT” is displayed on the display.



CT (Clock Time)

Use this to correct the time of the clock on this unit.

1 During CT reception, press **SETUP**.

“AUTO Adj hh:mm” is displayed.

2 Press **ENTER** to set.

“RDS hh:mm” is displayed.

- The time on the set's internal clock is updated to the currently displayed “CT” time.



- Do not operate any buttons while the time is being updated. If buttons are operated, CT reception is not possible and the time is not updated.



Listening to music on a Bluetooth device

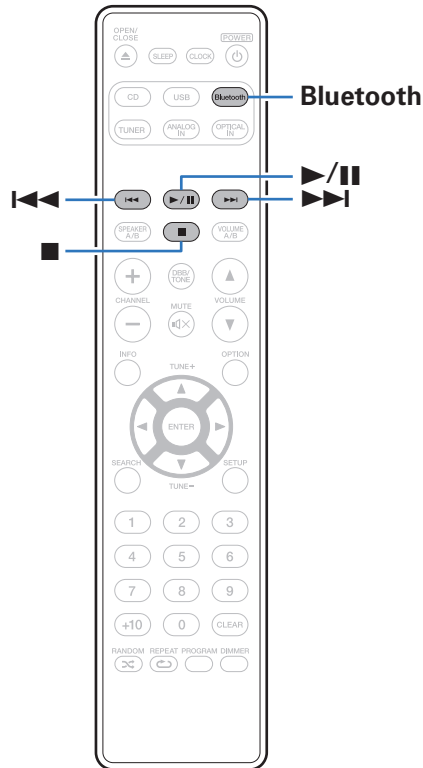

Music files stored on Bluetooth devices such as smartphones, digital music players, etc. can be enjoyed on this unit by pairing and connecting this unit with the Bluetooth device.

Communication is possible up to a range of about 30 m.

NOTE

- To play back music from a Bluetooth device, the Bluetooth device needs to support the A2DP profile.



Listening to music on a Bluetooth device

In order to enjoy music from a Bluetooth device on this unit, the Bluetooth device must first be paired with this unit.

Once the Bluetooth device has been paired, it does not need to be paired again.

1 Press Bluetooth to switch the input source to “Bluetooth”.

When using for the first time, the unit will go into the pairing mode automatically and “Pairing” will appear on the display of the unit.

2 Activate the Bluetooth settings on your Bluetooth device.

3 Select this unit when its name appears in the list of devices displayed on the screen of the Bluetooth device.

At the end of the pairing, the device name appears on the display of this unit.

- Connect to the Bluetooth device while “Pairing” is being displayed on the display of the unit.
Perform the connection with the Bluetooth device close to the unit (about 1 m).

4 Play music using any app on your Bluetooth device.

- The Bluetooth device can also be operated with the remote control of this unit.
- The next time the input source is switched to “Bluetooth”, this unit automatically connects to the last Bluetooth device that was connected.





- When “Marantz M-CR412” is not displayed in the screen on the Bluetooth device, search for devices on the Bluetooth device.
- Enter “0000” when the password is requested on the screen of the Bluetooth device.
- English letters, numbers and certain symbols are displayed. Incompatible characters are displayed as “.” (period).

NOTE

- The pairing mode on this unit lasts for approx. 5 minutes. When the pairing mode on this unit is canceled before the pairing is completed, retry from step 1.
- This unit cannot perform pairing against a Bluetooth device with a pass key other than “0000”.



| Operation buttons | Function |
|--|--|
|  | Playback / Pause |
|  | Skip to previous track / Skip to next track |
|  | (Press and hold) Fast-reverse / Fast-forward |

NOTE

- To operate the Bluetooth device with the remote control of this unit, the Bluetooth device needs to support the AVRCP profile.
- The remote control of this unit is not guaranteed to work with all Bluetooth devices.
- Depending on the type of Bluetooth device, this unit outputs audio that is coupled to the volume setting on the Bluetooth device.



Pairing with other Bluetooth devices

Pair a Bluetooth device with this unit.

1 Activate the Bluetooth settings on your Bluetooth device.

2 Press and hold Bluetooth for 3 seconds or longer.

This unit will go into the pairing mode.

- Pairing can also be done by pressing BLUETOOTH on the main unit.

3 Select this unit when its name appears in the list of devices displayed on the screen of the Bluetooth device.

At the end of the pairing, the device name appears on the display of this unit.



- This unit can be paired with a maximum of 8 Bluetooth devices. When a 9th Bluetooth device is paired, it will be registered in place of the oldest registered device.
- Enter "0000" when the password is requested on the screen of the Bluetooth device.

Reconnecting to this unit from a Bluetooth device

After pairing is completed, the Bluetooth device can be connected without performing any operations on this unit.

This operation also needs to be performed when switching the Bluetooth device for playback.

1 If a Bluetooth device is currently connected, deactivate the Bluetooth setting of that device to disconnect it.

2 Activate the Bluetooth setting of the Bluetooth device to be connected.

3 Select this unit from the Bluetooth device list on your Bluetooth device.

4 Play music using any app on your Bluetooth device.



- When the power of this unit and the Bluetooth function of this unit are turned on, the input source will be automatically switched to "Bluetooth" if a Bluetooth device is connected.
- When a Bluetooth device is connected with the unit in the Bluetooth standby state (the power indicator turns red), the power of the unit will be turned on automatically.



Playing digital input

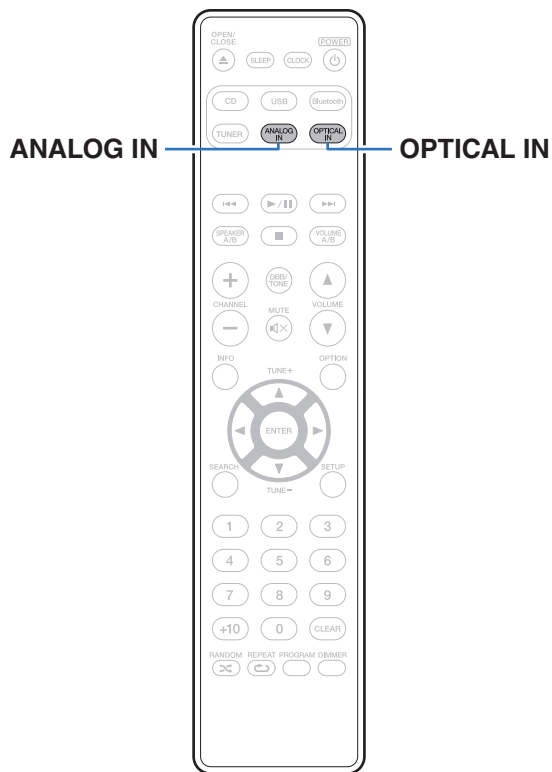

1 Prepare for playback.

Check the connection, then turn on this units. (“Connecting a digital device” (p. 24))

2 Press OPTICAL IN to switch the input source to “Optical In 1” or “Optical In 2”.

3 Play the component connected to this unit.

- If the sampling frequency cannot be detected, “Signal Unlock” will be displayed.
- “Unsupported” is displayed when audio signals that are not supported by this unit are input.





- When “TV Auto-Play” is set in the menu, this unit automatically turns on when the TV connected to the unit is turned on, and the input source switches to “Optical In 1” or “Optical In 2”. (🔗 p. 69)

NOTE

- Do not input non-PCM signals, such as Dolby Digital, DTS and AAC. This causes noise and could damage the speakers.

■ Specifications of supported audio formats

See “DIGITAL IN” (🔗 p. 93).

Playing analog input

1 Prepare for playback.

Check the connection, then turn on this units. (“Connecting an analog device” (🔗 p. 25))

2 Press ANALOG IN to switch the input source to “Analog In”.**3 Play the component connected to this unit.**

Convenience functions

- This section explains how to use convenient functions that can be used for each input source.

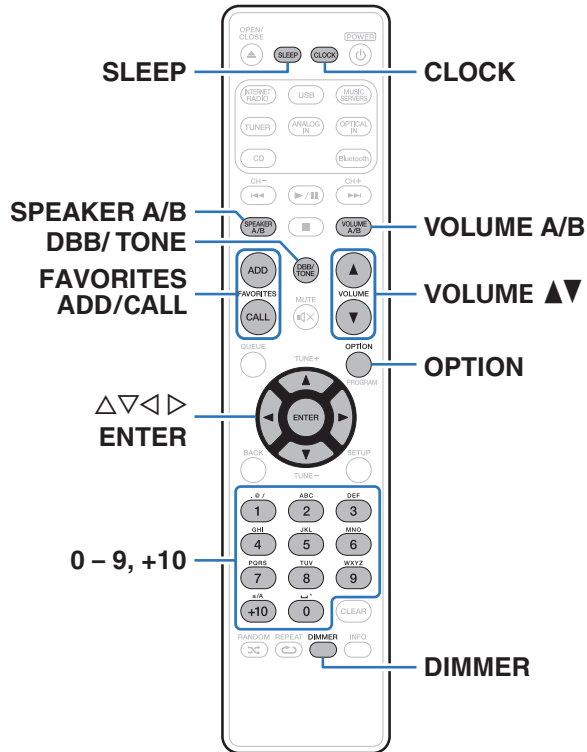

Adjusting the tone

- 1 Press **DBB/TONE** to select the tone parameter to be adjusted.
- 2 Use $\Delta \nabla$ to adjust “**DBB (Dynamic Bass Boost)**”, “**Bass**”, “**Treble**”, “**Balance**” or “**Source Direct**”.

❑ **DBB (Dynamic Bass Boost)**

| | |
|-----------------------|--|
| On: | Emphasizes the bass sound (maximum +8 dB). |
| Off (Default): | The DBB (Dynamic Bass Boost) function is not used. |

❑ **Bass**

Adjusts the bass sound.

-10 dB – +10 dB (Default : 0 dB)

❑ **Treble**

Adjusts the treble sound.

-10 dB – +10 dB (Default : 0 dB)

❑ **Balance**

Use $\triangleleft \triangleright$ to adjust the left/right volume balance.

❑ **Source Direct**

| | |
|-----------------------|---|
| On: | Playback sound is closer to the source sound. |
| Off (Default): | Do not use Source Direct function. |



- Even when the “Source Direct” setting is “On”, settings other than “Speaker Config” - “Response” in the menu can be set for “Flat”. (🔗 p. 66)



Switching the display's brightness

The display brightness can be adjusted between four levels.

1 Press DIMMER.

- The brightness of the display switches each time the button is pressed.



- If the buttons are operated when the display is turned off, information is displayed temporarily at a low brightness level.
- The display brightness is set to most brightly by default.

Using the sleep timer

You can have the power automatically switched to standby once a set time has elapsed. This is convenient for listening while going to sleep.

1 Press SLEEP during playback and select the setting time.

The "SLEEP" indicator on the display lights.

- The sleep timer can be set to up to 90 minutes, in steps of 10 minutes.

■ To cancel the sleep timer

1 Press SLEEP to select "Sleep Off".

The "SLEEP" indicator on the display turns off.



- The sleep timer setting is canceled when the unit switches to standby mode.
- To check the time remaining until the sleep timer is activated, press SLEEP.



Checking the current time

Be sure to set the current time using “Clock” in the setup menu in advance.

( p. 68)

■ Checking the current time when the power is on

Press CLOCK.

- Press once more and the display returns to its original condition.

■ Checking the current time when the power is set to standby

Press CLOCK.

- The current time is displayed for 30 seconds.



- When “Clock Mode” in the menu is set to “On”, the current time is continually displayed even when the power is set to standby. ( p. 69)
- The time cannot be set when in the standby mode. Turn on the power first.



Connecting multi-drive to listen to music in two rooms

You can listen to music in different rooms using this unit with two pairs of speaker systems.

■ Connecting speakers

Carefully check the left (L) and right (R) channels and + (red) and – (black) polarities on the speakers being connected to the unit, and be sure to connect the channels and polarities correctly.

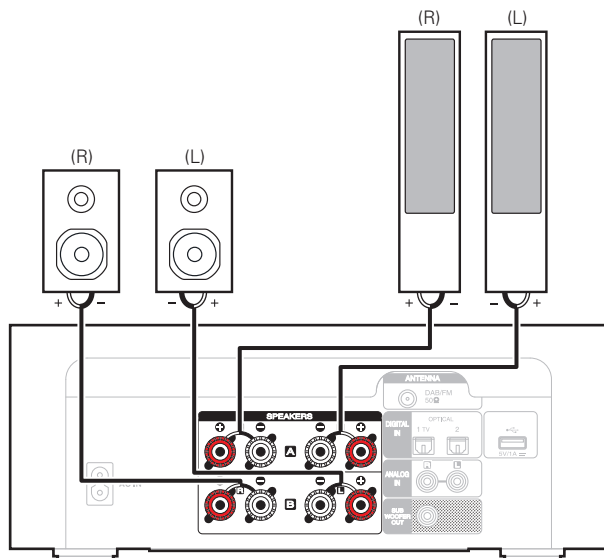

■ Selecting speakers to output audio

You can set up this unit to output audio from Speaker A, Speaker B, or both.

1 Press SPEAKER A/B.

The current setting is displayed.

2 Press SPEAKER A/B repeatedly to select the setting.

- The setting changes each time SPEAKER A/B is pressed.

Speakers A:

Outputs audio from Speaker A only.

Speakers B:

Outputs audio from Speaker B only.

Speakers A+B:

Outputs audio from both Speaker A and Speaker B.



- When using the multi-drive connection, set “Speaker Config” – “Amplifier Mode” in the settings menu to “Standard”. (🔗 p. 65)

■ Specifying speakers to adjust the volume

When 2 sets of speakers (Speaker A/Speaker B) are connected, either Speaker A or Speaker B can be selected for volume adjustment.

1 Press VOLUME A/B.

The speakers whose volume is to be adjusted are shown in the unit display.

2 Use VOLUME ▲▼ to adjust the volume.



- This is only enabled when “Speakers A+B” is set for the audio output speakers.



Menu map

For menu operations, see the following page.

By default, this unit has recommended settings defined. You can customize this unit based on your existing system and your preferences.

| Setting items | Detailed items | Description | Page | |
|---------------|----------------|--|------|----|
| Audio | H/P Amp Gain | Set the gain of the headphone amplifier. By setting according to the impedance of your headphone, you can enjoy playing headphones at an appropriate volume. | 65 | |
| | Speaker Config | The speaker output characteristics are changed and settings are configured according to your speakers. | 65 | |
| | | Amplifier Mode | | 65 |
| | | Response | | 66 |



| Setting items | Detailed items | Description/Detailed items | Page |
|----------------|---------------------|--|------|
| General | Alarm | Sets the timer playback. | 67 |
| | Clock | Sets the current time. | 68 |
| | Clock Mode | You can display the time when in standby by setting the "Clock Mode". | 69 |
| | TV Auto-Play | Set this when playing audio from a TV on this unit. | 69 |
| | RC Learning | Assign operations on this unit to the remote control of your TV. This enables you to operate this unit with the remote control of your TV. | 70 |
| | CD Auto-Play | Set whether to automatically play a disc when the disc is inserted. | 70 |
| | Illumination | You can set front panel illumination to on or off. | 70 |
| | Auto-Standby | Sets the unit power to standby when the unit is not in use. | 71 |
| | Bluetooth | Stopping Bluetooth function reduces a source of noise that affects sound quality, enabling higher sound quality playback. | 71 |
| | Reset | Various settings are reset to the factory default values. | 71 |



| Setting items | Detailed items | Description | Page |
|---------------|-----------------------------|--|------|
| DAB*1 | Tuning Aid | Displays the reception intensity for DAB antenna installation. | 72 |
| | Station Order | Sets the order of broadcasting stations to be displayed. | 72 |
| | DRC (Dynamic Range Control) | Sets dynamic range control. | 72 |
| | DAB Initialize | Resets the DAB modules. | 72 |
| | DAB Version | Displays DAB module version. | 72 |

*1 This is displayed when the input source is set to "DAB".



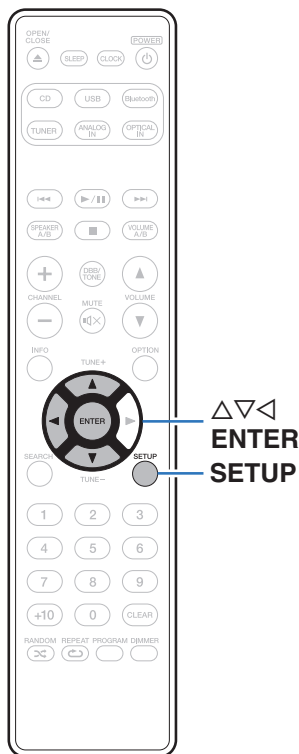

Menu operation

- 1 Press SETUP.**
The menu is displayed on the display.
- 2 Use Δ / ∇ to select the menu to be set or operated, then press ENTER.**
- 3 Use Δ / ∇ to change to desired setting.**
- 4 Press ENTER to enter the setting.**
 - To return to the previous item, press \triangleleft .
 - Exiting the Menu, press SETUP while the menu is displayed. The display returns to the normal display.



Audio

Make audio-related settings.

H/P Amp Gain

Set the gain of the headphone amplifier. Set this according to the impedance of the connected headphones. It is recommended that this is set on the “Low” side if the headphones have low impedance and on the “High” side if they have high impedance.

| | |
|-----------------------|--|
| High: | Set the gain of the headphone amplifier to “High”. Set when there is insufficient volume, even when the gain setting is “Mid”. |
| Mid (Default): | Set the gain of the headphone amplifier to “Mid”. |
| Low: | Set the gain of the headphone amplifier to “Low”. Set this if the volume is too high at the factory default setting. |

NOTE

- The headphone volume varies depending on the H/P Amplifier Gain setting. Decrease the volume or mute the audio first if changing this setting while listening to audio.

Speaker Config

The speaker output characteristics are changed and settings are configured according to your speakers.

■ Amplifier Mode

This unit is loaded with 4 channels of output (SPEAKERS A (L/R), SPEAKERS B (L/R)), for a maximum of two sets of speakers that support a variety of playback methods. Connect and set up the speakers for your preferred playback method in advance.

| | |
|----------------------------|--|
| Standard (Default): | When either SPEAKERS A terminals or SPEAKERS B terminals are connected (“Connecting speaker A (Standard connection)” (🔧 p. 21), “Connecting speaker B” (🔧 p. 22)) and when both SPEAKERS A and B terminals are connected as 2 sets of speakers in a multi-drive connection, set (🔧 p. 59). |
| Bi-Amp: | Enables the bi-amp function. Set when bi-amp is connected. (🔧 p. 23) |



■ Response

Switches the frequency characteristics of the speaker output. Set as desired.

| | |
|---------------------------|--|
| Flat (Default): | Properties are flat. |
| Response1: | Cuts low frequencies 40 Hz or under by -12 dB/oct. |
| Response2: | Cuts low frequencies 60 Hz or under by -12 dB/oct. |
| Response3: | Cuts low frequencies 80 Hz or under by -12 dB/oct. |
| Response4: | Cuts low frequencies 100 Hz or under by -12 dB/oct. |



- When the “Speaker Config” - “Amplifier Mode” setting is “Standard”, SPEAKERS A/B terminals can be set individually.
- The “Response” setting is not reflected in headphones, audio or subwoofer output.



General

Alarm

Audio from the set input source can be played back at a specified time. Use this to set playback for the same time every day, or set alarm playback on a certain day of the week. Set the current time in advance from "Clock" in the settings menu. (🔗 p. 68)

Alarm 1

| | |
|---|-------------------|
| Alarm start time - Repeat setting: | Enables Alarm 1. |
| Off: | Disables Alarm 1. |

Alarm 2

| | |
|---|-------------------|
| Alarm start time - Repeat setting: | Enables Alarm 2. |
| Off: | Disables Alarm 2. |



- When setting Alarm 1 or Alarm 2 for the first time after purchasing this unit, "Not Set" is displayed. Press ENTER to switch to the alarm start time setting screen. Follow steps 2 onward in "Edit Alarm" (next section).

Edit Alarm

Used to edit Alarm 1 or Alarm 2.

- Use $\Delta\nabla$ to select Alarm 1 or Alarm 2, then press ENTER.
- Use $\Delta\nabla$ to setting for the alarm start time, then press ENTER.
- Use $\Delta\nabla$ to select a repeat setting, then press ENTER.

| | |
|------------------|--|
| Never: | Alarm is not repeated. (single time only) |
| Everyday: | Alarm is repeated every day. |
| Weekdays: | Alarm is repeated on weekdays (Mon. to Fri.) only. |
| Weekends: | Alarm is repeated on weekends (Sat., Sun.) only. |
| Custom: | Used to set alarm on/off settings individually for each day of the week. Alarm is repeated only on days set to on. |



4 Use Δ / ∇ to select the input source, then press ENTER.

CD / Tuner / Optical In 1 / Optical In 2 / Analog In



- When "Tuner" is selected, select a preset number.

5 Use Δ / ∇ to select the volume level (0 – 100), then press ENTER.

- ⌚ lights in the display and the setting is completed.

Clock

Sets the current time.

- 1 Use Δ / ∇ to set the "day".
- 2 Press ENTER.
The "hours" display flashes.
- 3 Use Δ / ∇ to set the "hours".
- 4 Press ENTER.
The "minutes" display flashes.
- 5 Use Δ / ∇ to set the "minutes".
- 6 Press ENTER.



Clock Mode

You can display the time when in standby by setting the “Clock Mode”.

On: Time is displayed in standby.

Off
(Default): Time is not displayed in standby.



- When in standby and “Clock Mode” is set to “On”, the unit consumes more standby power than when in normal standby.

TV Auto-Play

Set this when playing audio from a TV on this unit. When the TV is turned on, this unit turns on and the input source is automatically switched to “Optical In 1” or “Optical In 2” so that the audio from the TV can be played through this unit.

Set this according to the connector on this unit where the TV is connected (Optical 1 or Optical 2).

Optical In 1 / Optical In 2 / Off (Default: Optical In 1)



RC Learning

Assign operations on this unit to the remote control of your TV. This enables you to operate this unit with the remote control of your TV.

1 Use $\Delta\nabla$ to select the operation on this unit to be performed with the remote control of your TV and press ENTER.

Volume Up / Volume Down / Mute / Power Toggle / Power On / Power Off / Optical In 1 / Optical In 2 / Analog In



- The operations indicated by a “**” mark are already assigned to the TV remote control. To assign an operation to a different button, press ENTER while the operation is indicated by a “**” mark to remove the “**” mark, then configure the setting again.

2 Follow the instructions in the display to configure the setting.

The set operation on this unit is indicated by a “**” mark after the setting is complete.



- Some remote controls may not be compatible with the “RC Learning” function.

CD Auto-Play

When the disc tray is closed, the unit can detect the CD, automatically switch the input source to “CD” and start playback.

| | |
|-------------------------|--------------------------------------|
| On (Default): | Performs automatic playback. |
| Off: | Does not perform automatic playback. |

Illumination

You can set front panel illumination to on or off.

| | |
|-------------------------|----------------------|
| On (Default): | Illuminates. |
| Off: | Does not illuminate. |



Auto-Standby

If there is no input signal and operation for 15 minutes, this unit automatically enters standby mode.

| | |
|-------------------------|--|
| On (Default): | The unit goes into standby after 15 minutes. |
| Off: | The unit does not go into standby automatically. |



- When the input source is “Tuner”, this unit automatically enters the standby mode when no operation is performed for 8 hours.

Bluetooth

Stopping Bluetooth function reduces a source of noise that affects sound quality, enabling higher sound quality playback.

| | |
|-------------------------|----------------------------------|
| On (Default): | Enables the Bluetooth function. |
| Off: | Disables the Bluetooth function. |



- When this unit enters standby and “Bluetooth” is set to “On”, Bluetooth also enters standby. While Bluetooth is in standby, this unit powers on automatically if it is connected to a paired device via Bluetooth.

Reset

Perform this procedure if the display is abnormal or if operations cannot be performed. Restores the contents of each setting to the factory settings. Make settings again.

| | |
|-----------------------|--------------------------|
| Reset Default: | Unit is initialized. |
| Cancel: | Unit is not initialized. |



- Selecting “Reset Default” also resets all Bluetooth device pairing information saved to this unit.



DAB

Making the DAB settings.

Tuning Aid

The reception intensity of the currently tuned in frequency is displayed. Use this if your preferred station cannot be received.

- 1** Use **<|>** to select a frequency to tune into. It takes around 4-5 seconds to correctly display the reception intensity (→) after selecting a frequency.
- 2** If necessary, adjust the position of the antenna so that the reception intensity (→) passes to the right of the **■** mark. The station can now be received.
- 3** Press **ENTER** to select the station and exit “Tuning Aid”.

Station Order

The service list is created with the auto scan function.

| | |
|--------------------------------|------------------------|
| Multiplex (Default): | In order of frequency. |
| Alphanumeric: | In alphabetical order. |

DRC (Dynamic Range Control)

Compress dynamic range (difference between loud and soft sounds).

Off / 1/2 / 1 (Default : Off)

DAB Initialize

When the “DAB Initialize” procedure is performed, all the preset memory settings for the stations and DABs are reset.

DAB Version

The DAB module’s version is displayed.



■ Contents

Tips

| | |
|--|----|
| I want to listen to high sound performance playback | 74 |
| I want to adjust the tone myself | 74 |
| I want sound playback that is faithful to the original sound | 74 |
| To display time in standby | 74 |
| I want to make the volume of the headphones the same as that of the speakers | 74 |
| Simple operations in the power off state | 75 |
| I want to set the optimized listening environment after changing the configuration/position of the speakers or changing a speaker to a new one | 75 |

Troubleshooting

| | |
|--|----|
| Power does not turn on/Power is turned off | 77 |
| LED is flashing | 77 |
| Operations cannot be performed through the remote control unit | 78 |
| Display on this unit shows nothing | 78 |
| No sound comes out | 79 |
| Sound is interrupted or noise occurs | 80 |
| Desired sound does not come out | 81 |
| USB memory devices cannot be played back | 82 |
| Bluetooth cannot be played back | 83 |
| Cannot playback Discs | 84 |
| Audio from digital devices cannot be played back (Optical) | 85 |
| The input source switches to "Optical In 1" or "Optical In 2" | 85 |



Tips

I want to listen to high sound performance playback

- Stopping Bluetooth function reduces a source of noise that affects sound quality, enabling higher sound quality playback. Set “Bluetooth” on the menu to “Off”. (👉 p. 71)

I want to adjust the tone myself

- Press the DBB/TONE button and set “DBB (Dynamic Bass Boost)”, “Bass”, “Treble” and “Balance”. (👉 p. 56)

I want sound playback that is faithful to the original sound

- Press the DBB/TONE button and set “Source Direct” to “On”. (👉 p. 56)

To display time in standby

- Time is displayed in standby when the “Clock Mode” setting is “On”. (👉 p. 69)

I want to make the volume of the headphones the same as that of the speakers

- You can adjust the sound from the headphones in three steps without changing the volume of the speaker by changing the “H/P Amp Gain” settings. (👉 p. 65)



Simple operations in the power off state

- When an input source select button or the OPEN/CLOSE ▲ button, ►/|| button or BLUETOOTH button, ▲ button or ►/|| button on the main unit is pressed, the operation is performed at the same time as the unit switches on.

I want to set the optimized listening environment after changing the configuration/position of the speakers or changing a speaker to a new one

- Set “General” - “Speaker Config” in the settings menu to “Response”. (👉 p. 66)



Troubleshooting

If a problem should arise, first check the following:

1. Are the connections correct?
2. Is the set being operated as described in the owner's manual?
3. Are the other devices operating properly?



If this unit does not operate properly, check the corresponding symptoms in this section.

If the symptoms do not match any of those described here, consult your dealer as it could be due to a fault in this unit. In this case, disconnect the power immediately and contact the store where you purchased this unit.



Power does not turn on / Power is turned off

Power is not turned on.

- Check whether the power plug is correctly inserted into the power outlet. (👉 p. 28)
- This unit is in standby mode. Press the  button on the unit or the POWER  button on the remote control. (👉 p. 30)

Power automatically turns off.

- The sleep timer is set. Turn on the power again. (👉 p. 57)
- The unit is set to auto standby mode. The auto standby mode automatically switches the unit to standby if there are no operations for more than 15 minutes. To disable auto standby mode, set “Auto-Standby” in the menu to “Off”. (👉 p. 71)

LED is flashing

Flashing red. (Flashes in 0.25-second intervals)

- This unit’s amplifier circuit has failed. Disconnect the power and contact the repair center.
- Core wires of two speakers are touching each other or a core wire is sticking out of the terminal and touching the set’s rear panel, activating the protection circuit. First unplug the power cord, then twist the core wires tightly or terminate the speaker cables, then reconnect.

Flashing red. (Flashes in 2-second intervals)

- Protection circuit activated due to a rise in internal temperature. Turn off the power, wait for the set to fully cool down, then turn the power back on.



Operations cannot be performed through the remote control unit

Operations cannot be performed through the remote control unit.

- Batteries are worn out. Replace with new batteries. (🔧 p. 7)
- Operate the remote control unit within a distance of about 7 m from this unit and at an angle of within 30°. (🔧 p. 7)
- Remove any obstacle between this unit and the remote control unit.
- Insert the batteries in the proper direction, checking the ⊕ and ⊖ marks. (🔧 p. 7)
- The unit's remote control sensor is exposed to strong light (direct sunlight, inverter type fluorescent bulb light, etc.). Move the set to a place in which the remote control sensor will not be exposed to strong light.
- When using a 3D video device, the remote control unit of this unit may not function due to effects of infrared communications between units (such as TV and glasses for 3D viewing). In this case, adjust the direction of units with the 3D communications function and their distance to ensure they do not affect operations from the remote control unit of this unit.
- Operations on this unit can be assigned to the remote controls of devices such as a TV using the "RC Learning" function of the unit. Please note, however, that some remote controls may not be compatible with the "RC Learning" function. (🔧 p. 70)

Display on this unit shows nothing

Display is off.

- Press the DIMMER button, and change the setting to anything other than off. (🔧 p. 57)



No sound comes out

No sound is produced. Or sound is distorted.

- Check the connections for all devices. (👉 p. 19)
- Insert connection cables all the way in.
- Check that input connectors and output connectors are not reversely connected.
- Check cables for damage.
- Check that speaker cables are properly connected. Check that cable core wires come in contact with the metal part on speaker terminals. (👉 p. 20)
- Securely tighten the speaker terminals. Check speaker terminals for looseness. (👉 p. 20)
- Check that the proper input source is selected. (👉 p. 31)
- Adjust the volume. (👉 p. 31)
- Cancel the mute mode. (👉 p. 31)
- Check that the correct input source is selected when audio is being input to this unit from an external device. (👉 p. 31)
- Check the digital audio output setting on the connected device. The initial settings may be off depending on the device.
- When a headphone plug is inserted into the headphone jack of the unit, no sound is output from the speakers. (👉 p. 12)
- Do not input non-PCM signals, such as Dolby Digital, DTS and AAC. This causes noise and could damage the speakers.
- To playback via a Bluetooth connection, perform pairing between this unit and the Bluetooth device. (👉 p. 49)
- It may be that only speaker A or speaker B is selected. Make sure the speakers are correctly connected then push the SPEAKER A/B button to check. (👉 p. 59)



Sound is interrupted or noise occurs

During playback from the USB memory device, sound is occasionally interrupted.

- When the transfer speed of the USB memory device is slow, sound may occasionally be interrupted.

When making a call on mobile phone, noise occurs in audio output on this unit.

- When making a call, keep a distance of 20 cm or longer between mobile phone and this unit.

During playback from the CD-R/CD-RW, sound is occasionally interrupted.

- The sound may skip during playback of a CD-R/CD-RW containing a high-resolution audio source.
- This may be caused by poor recording conditions, or the disc itself may be of poor quality. Use a correctly recorded disc.

Noise often occurs in DAB/FM broadcasting.

- Change the antenna orientation or position. (👉 p. 27)
- Use an outdoor antenna. (👉 p. 27)
- Separate the antenna from other connection cables. (👉 p. 27)



Desired sound does not come out

Headphone volume is low.

- Switch “H/P Amp Gain” to “High” if using headphones with high impedance or low sensitivity. (👉 p. 65)

Left/right volume balance is unbalanced.

- Press the DBB/TONE button on the remote control to adjust the “Balance”. (👉 p. 56)

No sound is produced from subwoofer.

- Check the subwoofer connections. (👉 p. 21)
- Turn on the subwoofer’s power.
- When the speaker for audio output is set to “Speakers B”, this unit does not output to the subwoofer. Switch to “Speakers A”. (👉 p. 60)

Set values are not reflected in “DBB (Dynamic Bass Boost)”, “Bass” and “Treble”.

- The “DBB (Dynamic Bass Boost)”, “Bass” and “Treble” setting values are not reflected in audio out or subwoofer out.
- Press the DBB/TONE button on the remote control to set “Source Direct” to “Off”. (👉 p. 56)



USB memory devices cannot be played back

USB memory device is not recognized.

- Disconnect and reconnect the USB memory device. (👉 p. 26)
- Mass storage class compatible USB memory devices are supported.
- This unit does not support a connection through a USB hub. Connect the USB memory device directly to the USB port.
- The USB memory device must be formatted to FAT16 or FAT32.
- Not all USB memory devices are guaranteed to work. Some USB memory devices are not recognized. When using a type of portable hard disc drive compatible with the USB connection that requires power from an AC adapter, use the AC adapter that came with the drive.

Files on the USB memory device are not displayed.

- Files of a type not supported by this unit are not displayed. (👉 p. 38)
- This unit is able to display files in a maximum of eight folder layers. A maximum of 255 folders and 65025 files can be stored. Modify the folder structure of the USB memory device.
- When multiple partitions exist on the USB memory device, only files on the first partition are displayed.

iOS and Android devices are not recognized.

- The USB port of this unit does not support playback from iOS and Android devices.

Files on a USB memory device cannot be played.

- Files are created in a format that is not supported by this unit. Check the formats supported by this unit. (👉 p. 88)
- You are attempting to play a file that is copyright protected. Files that are copyright protected cannot be played on this unit.
- Playback may not be possible if the album art file size exceeds 2 MB.



Bluetooth cannot be played back

Bluetooth devices cannot be connected to this unit.

- The Bluetooth function in the Bluetooth device has not been enabled. See the Owner's Manual of the Bluetooth device to enable the Bluetooth function.
- Bring the Bluetooth device near to this unit.
- The Bluetooth device cannot connect with this unit if it is not compatible with the A2DP profile.
- Turn the power of the Bluetooth device off and on again, and then try again.
- Set "Bluetooth" on the menu to "On". The Bluetooth function does not work when "Bluetooth" is "Off".
( p. 71)

The sound is cut off.

- Bring the Bluetooth device near to this unit.
- Remove obstructions between the Bluetooth device and this unit.
- To prevent electromagnetic interference, locate this unit away from microwave ovens, wireless LAN devices and other Bluetooth devices.
- Reconnect the Bluetooth device.



Cannot playback Discs

Cannot playback when the play button is pressed, or cannot correctly play back a specific part of the disc.

- The disc is dirty or scratched. Either clean the disc, or insert a different disc. (👉 p. 92)

Cannot playback CD-R/CD-RW.

- Discs cannot be played back unless they have been finalized. Use a finalized disc. (👉 p. 86)
- This may be caused by poor recording conditions, or the disc itself may be of poor quality. Use a correctly recorded disc.
- Files are created in a format that is not supported by this unit. Check the formats supported by this unit. (👉 p. 87)

“No Disc” is displayed.

- “No Disc” is displayed if the disc is loaded upside-down or if no disc is loaded.

“System Error” is displayed.

- “System Error” is displayed when an error not caused by disc, format, etc., occurs.

“Can't Read Disc” is displayed.

- “Can't Read Disc” is displayed when the inserted disc cannot be read because it is not compatible with this unit or is dirty or scratched.

“Wrong Format” is displayed.

- “Wrong Format” is displayed for files created in a format that is not supported by this unit. Check the formats supported by this unit. (👉 p. 87)



Audio from digital devices cannot be played back (Optical)

“Signal Unlock” is displayed.

- When digital audio signals cannot be detected properly, “Signal Unlock” is displayed. (👉 p. 53)

“Unsupported” is displayed.

- “Unsupported” is displayed when audio signals that are not supported by this unit are input. Check the audio output signal format from your digital device. (👉 p. 53)



The input source switches to “Optical In 1” or “Optical In 2”

The input source automatically switches to “Optical In 1” or “Optical In 2” when the TV connected to this unit is turned on.

- Set “TV Auto-Play” on the menu to “Off”. (👉 p. 69)



Playing back Discs

| Playable media | |
|----------------|---|
| CD |  |
| CD-R |  |
| CD-RW |  |

NOTE

- Some discs and some recording formats cannot be played.
- Non-finalized discs cannot be played.

Files

CD-R and CD-RW discs created in the format described below can be played.

■ Writing software format

ISO9660 level 1

- When written in other formats, it may not be possible to play the disc properly.

■ Maximum number of playable files and folders

Total number of folders and files : 512

Maximum number of folders : 256

■ File format

MPEG-1 Audio Layer-3

WMA (Windows Media Audio)

■ Tag data

ID3-TAG (Ver.1.x and 2.x)

META-Tag (Compatible with title, artist and album names)



■ Specifications of supported files

| | Sampling frequency | Bit rate | Extension |
|-----|--------------------|---------------|-----------|
| MP3 | 32/44.1/48 kHz | 48 – 320 kbps | .mp3 |
| WMA | 32/44.1/48 kHz | 48 – 320 kbps | .wma |

NOTE

- Be sure to give files the extension. Files with any other extensions or files with no extensions cannot be played.
- Mac OS files assigned with filenames that begin with “.” are not music data and cannot be played back.
- Recordings you have made should only be used for your personal enjoyment, and as per copyright laws may not be used in other ways without permission of the copyright holder.



- Only music files that are not copyright-protected can be played on this unit.
 - Content downloaded from pay sites on the Internet are copyright protected. Also, files encoded in WMA format when ripped from a CD, etc. on a computer may be copyright protected, depending on the computer's settings.
- The maximum number of files and folders that can be played differs depending on conditions such as the length of the file name or folder name or the number of levels in the folder hierarchy.



Playing back a USB memory devices

- This unit is compatible with MP3 ID3-Tag (Ver. 2) standard.
- This unit is compatible with WMA META tags.
- If the image size (pixels) of an album artwork exceeds 500 × 500 (WMA/MP3/Apple Lossless/DSD) or 349 × 349 (MPEG-4 AAC), then music may not be played back properly.

■ Specifications of supported files

| | Sampling frequency | Bit rate | Extension |
|------------------|--------------------------------------|---------------|----------------|
| WMA*1 | 32/44.1/48 kHz | 48 – 320 kbps | .wma |
| MP3 | 32/44.1/48 kHz | 48 – 320 kbps | .mp3 |
| WAV | 32/44.1/48/88.2/ 96/176.4/192 kHz | – | .wav |
| MPEG-4 AAC*1 | 32/44.1/48 kHz | 48 – 320 kbps | .aac/.m4a/.mp4 |
| FLAC | 32/44.1/48/88.2/ 96/176.4/192 kHz | – | .flac |
| Apple Lossless*2 | 32/44.1/48/88.2/96 kHz | – | .m4a |
| AIFF | 32/44.1/48/88.2/ 96/176.4/192 kHz | – | .aif/.aiff |
| DSD | 2.8/5.6 MHz | – | .dsf/.dff |

*1 Only files that are not protected by copyright can be played on this unit.
Content downloaded from pay sites on the Internet are copyright protected. Also, files encoded in WMA format when ripped from a CD, etc. on a computer may be copyright protected, depending on the computer's settings.

*2 The Apple Lossless Audio Codec (ALAC) decoder is distributed under the Apache License, Version 2.0 (<http://www.apache.org/licenses/LICENSE-2.0>).



■ Maximum number of playable files and folder

The limits on the number of folders and files that can be displayed by this unit are as follows.

| Item | Media | USB memory device |
|--------------------------------------|-------|-------------------|
| Number of folder directory levels *1 | | 8 levels |
| Number of folders | | 255 |
| Number of files*2 | | 65025 |

*1 The limited number includes the root folder.

*2 The allowable number of files may differ according to the USB memory device capacity and the file size.

Playback order of music files

When there are multiple folders containing music files, the playback order of folders is automatically set when this unit reads the media. Files in each folder are played in alphabetical order of file name.

CD-R/CD-RW and USB memory device

For playback of files on CD-R, CD-RW or USB memory device, files in all folders on the first layer are played first, next on the second layer, then next on the third layer, and so on in this order.



- The playback order displayed on a PC may differ from the actual playback order.
- The playback order with a CD-R/CD-RW may differ, depending on the writing software.
- The playback order may differ from the order in which the folders or files were recorded if you delete or add a folder or file on USB. This occurs because of data recording specifications and is not a malfunction.



About discs and files

Music files recorded on CD-R/-RW and USB memory device are divided into large segments (folders) and small segments (files).

Files are stored in folders, and folders can be placed for storage in a hierarchy. The unit can recognize up to 8 levels of folders.

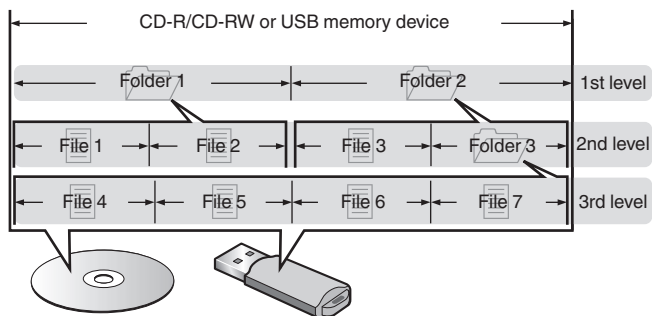

- When writing music files on a CD-R/CD-RW disc, set the writing software's format to "ISO9660". The files may not play properly if they are recorded in other formats. For details, refer to the instructions of your writing software.



Cautions on using media

Inserting a disc

- Set the disc in the tray label side up.
- Make sure the disc tray is fully open when inserting the disc.
- Place the discs flatly, 12 cm discs in the outer tray guide (Figure 1), 8 cm discs in the inner tray guide (Figure 2).

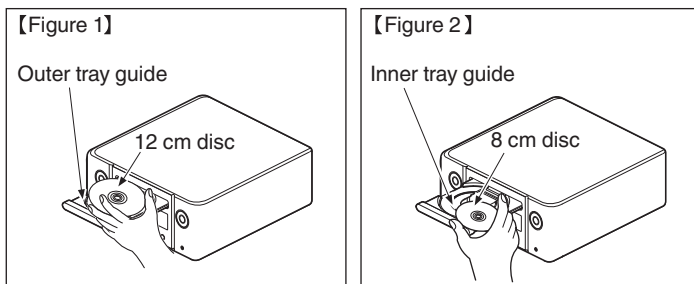

- Place 8 cm discs in the inner tray guide without using an adapter.

NOTE

- Only load one disc at a time. Loading two or more discs can damage the unit or scratch the discs.
- Do not use cracked or warped discs or discs that have been repaired with adhesive, etc.
- Do not use discs on which the sticky part of cellophane tape or labels is exposed or on which there are traces of where labels have been removed. Such discs can get caught inside the player and damage it.
- Do not use discs in special shapes, as they may damage the unit.



- Do not push the disc tray in by hand when the power is off. Doing so could damage the unit.
- Do not place any foreign objects in the disc tray. Doing so could result in damage.
- If the unit is left in a room full of smoke from cigarettes, etc., for long periods of time, the surface of the optical pickup may get dirty, preventing it from receiving signals properly.



How to handle media

- Do not get fingerprints, oil or dirt on discs.
- Take special care not to scratch discs when removing them from their cases.
- Do not bend or heat discs.
- Do not enlarge the hole in the center.
- Do not write on the labeled (printed) surface with ball-point pens, pencils, etc., or stick new labels on discs.
- Condensation may form on discs if they are moved suddenly from a cold place (outdoors for example) to a warm place, but do not try to dry discs with a hairdryer, etc.
- Do not eject a USB memory device or turn off the unit while a USB memory device is being played. This may result in malfunction or loss of the USB memory device's data.
- Do not attempt to open or modify a USB memory device.
- USB memory device and files can be damaged by static electricity. Do not touch the metal contacts of a USB memory device with your fingers.
- Do not use warped USB memory device.
- After use, be sure to remove any disc or USB memory device, and store it in its proper case, to avoid dust, scratches and deformation.
- Do not store discs in the following places:
 1. Places exposed to direct sunlight for long periods of time
 2. Dusty or humid places
 3. Places exposed to heat from heaters, etc.

Cleaning discs

- If there are fingerprints or dirt on a disc, wipe them off before using the disc.
- Use a commercially available disc cleaning set or a soft cloth to clean discs.



Gently wipe the disc from the inside towards the outside.

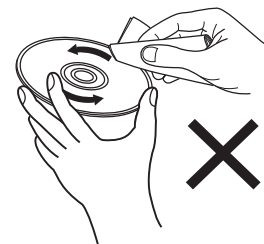

Do not wipe with a circular motion.

NOTE

- Do not use record spray, antistatic agents, benzene, thinner or other solvents.



DIGITAL IN

■ Specifications of supported audio formats

□ Optical

| | Sampling frequency | Bit length |
|---------------------------|--------------------------------------|------------|
| Linear PCM (2-channel) | 32/44.1/48/88.2/ 96/176.4/192 kHz | 16/24 bits |

Playing back a Bluetooth device

This unit supports the following Bluetooth profile.

- A2DP (Advanced Audio Distribution Profile):
When a Bluetooth device that supports this standard is connected, monaural and stereo sound data can be streamed at a high quality.
- AVRCP (Audio/Video Remote Control Profile):
When a Bluetooth device that supports this standard is connected, the Bluetooth device can be operated from this unit.

■ About Bluetooth communications

Radio waves broadcast from this unit may interfere with the operation of medical devices. Make sure you turn off the power of this unit and Bluetooth device in the following locations as radio wave interference may cause malfunctions.

- Hospitals, trains, aircraft, petrol kiosks and places where flammable gases are generated
- Near automatic doors and fire alarms

Last function memory

This function stores the settings which were made before going into the standby mode.



Explanation of terms

■ Audio

AIFF (Audio Interchange File Format)

This is an uncompressed and lossless format for digital audio. Use AIFF files to burn high-quality audio CDs from imported songs. AIFF files use approximately 10 MB of disk space per minute.

Apple Lossless Audio Codec

This is a codec for lossless audio compression method developed by Apple Inc. This codec can be played back on iTunes, iPod or iPhone. Data compressed to approximately 60 – 70 % can be decompressed to exactly the same original data.

DSD (Direct-Stream Digital)

One of the audio data recording methods, it is the signal aspect used to store audio signals on a super audio CD, and is Δ - Σ modulated digital audio.

FLAC (Free Lossless Audio Codec)

FLAC stands for Free lossless Audio Codec, and is a lossless free audio file format. Lossless means that the audio is compressed without any loss in quality.

The FLAC license is as shown below.

Copyright (C) 2000,2001,2002,2003,2004,2005,2006,2007,2008,2009
Josh Coalson

Redistribution and use in source and binary forms, with or without modification, are permitted provided that the following conditions are met:

- Redistributions of source code must retain the above copyright notice, this list of conditions and the following disclaimer.
- Redistributions in binary form must reproduce the above copyright notice, this list of conditions and the following disclaimer in the documentation and/or other materials provided with the distribution.
- Neither the name of the Xiph.org Foundation nor the names of its contributors may be used to endorse or promote products derived from this software without specific prior written permission.



THIS SOFTWARE IS PROVIDED BY THE COPYRIGHT HOLDERS AND CONTRIBUTORS "AS IS" AND ANY EXPRESS OR IMPLIED WARRANTIES, INCLUDING, BUT NOT LIMITED TO, THE IMPLIED WARRANTIES OF MERCHANTABILITY AND FITNESS FOR A PARTICULAR PURPOSE ARE DISCLAIMED. IN NO EVENT SHALL THE FOUNDATION OR CONTRIBUTORS BE LIABLE FOR ANY DIRECT, INDIRECT, INCIDENTAL, SPECIAL, EXEMPLARY, OR CONSEQUENTIAL DAMAGES (INCLUDING, BUT NOT LIMITED TO, PROCUREMENT OF SUBSTITUTE GOODS OR SERVICES; LOSS OF USE, DATA, OR PROFITS; OR BUSINESS INTERRUPTION) HOWEVER CAUSED AND ON ANY THEORY OF LIABILITY, WHETHER IN CONTRACT, STRICT LIABILITY, OR TORT (INCLUDING NEGLIGENCE OR OTHERWISE) ARISING IN ANY WAY OUT OF THE USE OF THIS SOFTWARE, EVEN IF ADVISED OF THE POSSIBILITY OF SUCH DAMAGE.

MP3 (MPEG Audio Layer-3)

This is an internationally standardized audio data compression scheme, using the "MPEG-1" video compression standard. It compresses the data volume to about one eleventh its original size while maintaining sound quality equivalent to a music CD.

MPEG (Moving Picture Experts Group), MPEG-2, MPEG-4

These are the names for digital compression format standards used for the encoding of video and audio. Video standards include "MPEG-1 Video", "MPEG-2 Video", "MPEG-4 Visual", "MPEG-4 AVC". Audio standards include "MPEG-1 Audio", "MPEG-2 Audio", "MPEG-4 AAC".

WMA (Windows Media Audio)

This is the audio compression technology developed by Microsoft Corporation.

WMA data can be encoded using Windows Media® Player.

To encode WMA files, only use applications authorized by Microsoft Corporation. If you use an unauthorized application, the file may not work properly.



Sampling frequency

Sampling involves taking a reading of a sound wave (analog signal) at regular intervals and expressing the height of the wave at each reading in digitized format (producing a digital signal).

The number of readings taken in one second is called the “sampling frequency”. The larger the value, the closer the reproduced sound is to the original.

Speaker impedance

This is an AC resistance value, indicated in Ω (ohms).

Greater power can be obtained when this value is smaller.

Bit rate

This expresses the read amount per 1 second of video/audio data recorded in a disc. A larger number means higher sound quality, but also means a larger file size.

Other**Finalizing**

This process enables DVD/CD recorded with a recorder to be played by other players.

Pairing

Pairing (registration) is an operation that is required in order to connect a Bluetooth device to this unit using Bluetooth. When paired, the devices authenticate each other and can connect without mistaken connections occurring.

When using Bluetooth connection for the first time, you need to pair this unit and the Bluetooth device to be connected.

Protection circuit

This is a function to prevent damage to devices within the power supply when an abnormality such as an overload, excess voltage occurs or over temperature for any reason.



Trademark information



The Bluetooth® word mark and logos are registered trademarks owned by the Bluetooth SIG, Inc. and any use of such marks by D&M Holdings Inc. is under license. Other trademarks and trade names are those of their respective owners.



Specifications

■ Audio amplifier

- CD player

| | |
|-------------------------------------|--|
| Playable frequency response: | 10 Hz – 20 kHz |
| Wow & flutter: | Below measurable limits (± 0.001 %) |
| Sampling frequency: | 44.1 kHz |

- Audio amplifier

| | |
|--|--|
| Rated output: | 2-channel driving 50 W + 50 W (6 Ω /ohms, 1 kHz, THD+N 0.7 %) |
| Dynamic power: | 60 W + 60 W (6 Ω /ohms, 1 kHz, THD+N 10 %) |
| Output terminals: | Speaker: 4-16 Ω /ohms (impedance) Compatible with headphones/stereo headphones |
| Input sensitivity/impedance: | Analog In : 200 mV/30 k Ω /kohms |
| Total harmonic distortion (1 kHz, 5 W, 6 Ω/ohms): | Analog In: 0.1 % |
| S/N ratio (10 W, 6 Ω/ohms, IHF-A): | Analog In : 90 dB |
| Tone control: | DBB : +8 dB (100 Hz) Bass : ± 10 dB (100 Hz) Treble : ± 10 dB (10 kHz) |
| Frequency response: | Analog In : 10 Hz – 40 kHz (± 3 dB) |



■ Tuner section

| | |
|-------------------------------|---------------------------------------|
| Receiving Range: | [FM] 87.50 MHz – 108.00 MHz |
| Effective sensitivity: | 1.2 μ V/50 Ω /ohms |
| FM Channel separation: | 30 dB (1 kHz) |
| FM S/N ratio: | Monaural : 65 dB Stereo : 65 dB |
| FM THD+N (1 kHz): | Monaural : 1 % Stereo : 1 % |

■ DAB tuner section

| | |
|-------------------------|--|
| Receiving Range: | 174.928 (5A) – 239.200 (13F) MHz (BAND III) |
| Sensitivity: | –85 dBm |
| S/N ratio: | 95 dB |



■ Bluetooth section

| | |
|-------------------------------------|--|
| Communications system: | Bluetooth Specification Version 4.0 + EDR (Enhanced Data Rate) |
| Transmission power: | Bluetooth Specification Power Class 1 |
| Maximum communication range: | Approx. 30 m in line of sight* |
| Used frequency range: | 2.4 GHz |
| Modulation scheme: | FHSS (Frequency-Hopping Spread Spectrum) |
| Supported profiles: | A2DP (Advanced Audio Distribution Profile) 1.3 AVRCP (Audio Video Remote Control Profile) 1.5 |
| Corresponding codec: | SBC, AAC |
| Transmission range (A2DP): | 20 Hz – 20,000 Hz |

* The actual communication range varies depending on the influence of such factors as obstructions between devices, electromagnetic waves from microwave ovens, static electricity, cordless phones, reception sensitivity, antenna performance, operating system, application software etc.





■ Clock/Alarm/Sleep

| | |
|--------------------|--|
| Clock type: | Power line frequency synchronized method (Within ± 60 seconds per month) |
| Alarm: | Alarm 1/Alarm 2: 2 types |
| Sleep: | Sleep timer: Max. 90 minutes |

■ General

| | |
|---|--------------------------|
| Operating temperature: | +5 °C - +35 °C |
| Power supply: | AC 220 - 230 V, 50/60 Hz |
| Power consumption: | 55 W |
| Power consumption in standby modes : | |

| Standby modes | Setting items in the menu | | Power consumption |
|---|--|--|-------------------|
| | TV Auto-Play ( p. 69) | Bluetooth ( p. 71) | |
| Normal standby ("TV Auto-Play" - "Optical In 1/Optical In 2") | Optical In 1/Optical In 2 | Off | 0.2 W |
| Normal standby ("TV Auto-Play" - "Off") | Off | Off | 0.2 W |
| Bluetooth standby ("TV Auto-Play" - "Optical In 1/Optical In 2") | Optical In 1/Optical In 2 | On | 0.7 W |
| Bluetooth standby ("TV Auto-Play" - "Off") | Off | On | 0.7 W |

- For purposes of improvement, specifications and design are subject to change without notice.



■ Dimensions (Unit : mm)

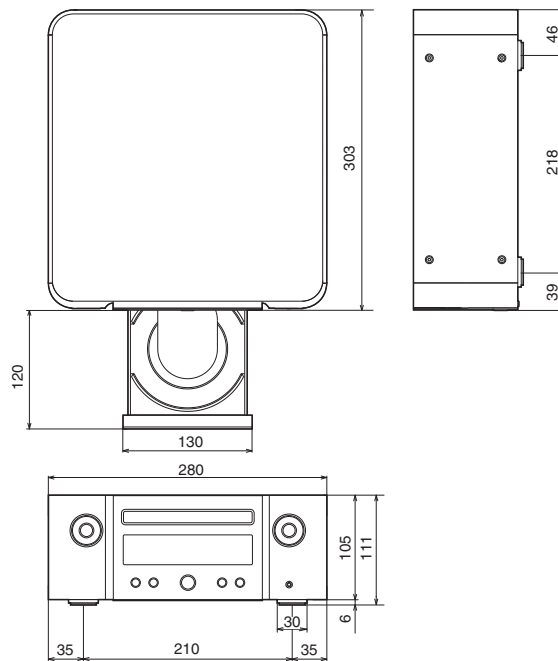

■ Weight : 3.3 kg



Index

| | | |
|----------------------------|--------|--|
| A | | |
| Auto Standby | 71 | |
| B | | |
| Bluetooth device | 49 | |
| C | | |
| CD | 32 | |
| D | | |
| DATA CD | 35 | |
| Display's brightness | 57 | |
| F | | |
| Front panel | 10 | |
| I | | |
| Input source | 31 | |
| M | | |
| Menu map | 61 | |
| P | | |
| Pairing | 49 | |
| Program playback | 34 | |
| R | | |
| Rear panel | 13 | |
| Remote control unit | 15 | |
| S | | |
| Sleep timer | 57 | |
| T | | |
| Tips | 74 | |
| Troubleshooting | 76 | |
| U | | |
| USB memory device | 26, 38 | |



www.marantz.com

You can find your nearest authorized distributor or dealer on our website.

marantz[®] is a registered trademark.

3520 10654 00AM

Copyright © 2019 D&M Holdings Inc. All Rights Reserved.